

06, 2024  
Volume 2 Issue 2



# Agricultural & Rural Studies

EDITOR-IN-CHIEF: JUNBIAO ZHANG



ISSN 2959-9784



02 >



<https://sccpress.com/index.php/ars>



ISSN 2959-9784



## Cover Story

Chinese freshwater cultured pearls (FWCPs) are assuming a growing role at major gem and jewelry fairs, and in the market at large. The unique characteristics of the Chinese FWCP—in terms of size, shape, and color—have been key to this popularity.

The culturing of freshwater pearls was widespread in China by the 13th century. Commercial freshwater pearl cultivation in China, however, dates back only to the late 1960s and early 1970s, when tremendous quantities of small, irregularly shaped “Rice Krispie” FWCPs entered the market.

Chinese FWCPs were initiated in Jiangsu and Zhejiang provinces, and then gradually expanded to other areas along the Yangtze River. Located in the northeast of Zhuji City, Zhejiang Province, Shanxiahu Town is known as the “Hometown of Pearls” throughout the country.

In Zhuji, the FWCPs began in the 1970s. After more than 10 years of exploration and development, the initial formation of Shanxiahu Town as the center of the Pearl Cultivation Base, in early 1985 established the original Pearl Market. Today, Zhuji has a fifth-generation market for professional pearls. After decades of development, Zhuji has become China’s largest freshwater pearl farming, processing and marketing center. Zhuji FWCPs industry has embarked on the road of large-scale, intensive and specialized production.

(Li Wang, Professor of Pearl College of China, Zhejiang A&F University, Zhejiang, China.)



# Agricultural & Rural Studies

---

Vol. 2, No.2 June, 2024

## Contents

- 0007 [Metabolic Aspects of Rural Life and Settlement Coexistence in China](#)  
Peter G. Rowe and Yoeun Chung
- 0008 [Economic Analysis of the Behavior of Prices and Market Arrivals of Tomatoes – A Case Study of West Bengal, India](#)  
Sourakanti Sarkar, Sumanta Das, Suman Dutta, Bimal Bera, Mahadev Bera, Debasish Roy, Md. Mahmudul Hasan Middya and Malini Roy Choudhury
- 0009 [Comparative Study of Agricultural Extension Methods Used by the Public and Private Sectors Before and During COVID-19 Pandemic in Myanmar: A Case Study](#)  
Nwaye Ei Khing Phyu, Htar Htar Win, Htet Oo Khin, Win Mar Htay, Hein Zaw, Chaw Su Aye, Nyein Nyein Htwe Htwe, Sein Lwin Aung, Soe Paing Oo and Nan Yu Maw
- 0010 [Designing and Analyzing Properties of Socio-Culture and Perception from Livestock Farmers: An Evidence in Utilizing Oil Palm Plantation Land-Use of West Papua](#)  
Deny Anjelus Iyai, Ambo Ako, Yubelince Yustenci Runtuboi, Sitti Nurani Sirajuddin, Petrus Abraham Dimara, Budiman Nohong, Amilda Auri, Novita Panambe, Stepanus Pakage and Nithanel M. H. Benu
- 0011 [The Effect of Covid-19 on Rural Sport: A Case Study of Endurance GB](#)  
Julie Jones
- 0012 [Credit Risk Game Analysis and Control Model of RMSEs—Based on the Perspective of Green Credit](#)  
Xi Zhou, Chuang Yang, Caiyu Wan, Wei Gao, Suping Ye, Lingyan Wu and Luyao Liu

# About the Journal

Agricultural & Rural Studies (**A&R, ISSN 2959-9784**) is a quarterly journal to be an international, multi-/inter-disciplinary platform for communicating advances in fundamental and applied studies on contemporary agricultural, rural and farmers' issues and policies, as broadly defined by the disciplines of economics, sociology, human geography and cognate subjects.

A&R is a digital-only, double-blind peer-reviewed, open-access (OA) journal. Article Publishing Charges (APC) are waived in the first four years. The journal publishes various materials – perspective, review, original research, and commentary articles – and it is dedicated to serving as an efficient, professional, and innovative platform for scholars in the field of agricultural and rural studies.

In a nutshell, the A&R Journal:

(1) covers multidisciplinary and interdisciplinary subjects such as economics, sociology, human geography and cognate subjects that are relevant to contemporary agricultural, rural and farmers' issues and policies.

(2) Is served by a renowned, dedicated, and international editorial board.

(3) Is a fully independent Open Access (OA) platform: [www.sccpress.com](http://www.sccpress.com), which promotes your article worldwide.

(4) Offers supportive, efficient, and professional publication services. We understand that authors are unique, and each paper is different. That is why our full-time professional editors are ready to help authors with structure matters and support them with reference management to simplify their research life.

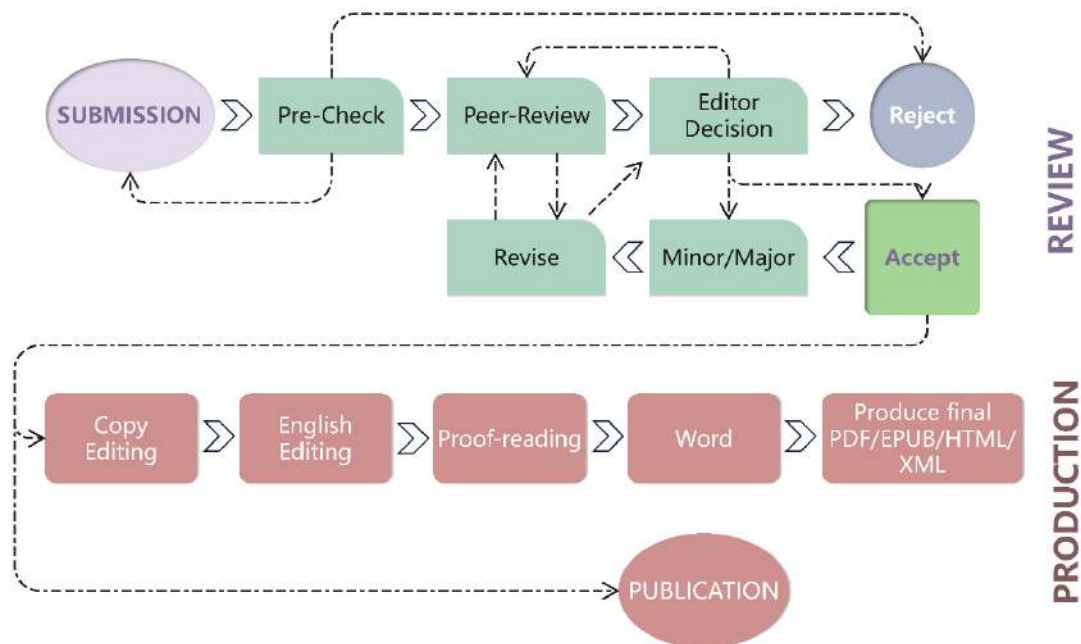

Perspective

# Metabolic Aspects of Rural Life and Settlement Coexistence in China

Peter G. Rowe \* and Yoeun Chung \* 

Graduate School of Design, Harvard University, Cambridge, MA 02114, US; [prowe@gsd.harvard.edu](mailto:prowe@gsd.harvard.edu) (P.G.R.); [yoeunchung@gsd.harvard.edu](mailto:yoeunchung@gsd.harvard.edu) (Y.C.)

\* Correspondence: [prowe@gsd.harvard.edu](mailto:prowe@gsd.harvard.edu) (P.G.R.); [yoeunchung@gsd.harvard.edu](mailto:yoeunchung@gsd.harvard.edu) (Y.C.)

**Abstract:** Among realms of settlement coexistences, *desakota* areas or *Township-Village-Enterprises* in China stand out as relatively conservative of material and other resources, including embodied energy. Chencun Village in the Shunde District of Guangdong Province is an agriculturally productive example of such a settlement covering some 131 hectares in area and hosting some 6,000 inhabitants, including villagers and migrant so-called “floating” households. Formerly a center of sericulture, the village now produces flowers and plants, alongside some factory operations making needed hardware in support of agriculture. From a metabolic perspective consisting of what Chencun is made of in material flows of stocks, including material extracted from the Geosphere, Biosphere, and Hydrosphere resulting in building materials, buildings, and land-uses, alongside of collected waste and recycling, the village’s environmental performance is comparatively better than many other forms of settlement coexistence. Measured by stock-flow models represented by Sankey Diagrams, Chencun registers slightly lower than an average of 4.0 MJ/Kg/Yr. or about 106 metric tons of building material per year, below that of more compact and even peripheral modes of settlement. Water use, though very present due to agricultural production takes place in a non-water-stressed part of China and benefits from graywater recycling. Energy use is likewise relatively restrained due to the small amount of transportation and the largely compact and stay-at-home pattern of *desakota* life. Further, such *desakota* forms of settlement should be preserved as more environmentally suitable than denser and more profligate forms of settlement in emerging Metropolitan Regions of China like the Greater Bay Area.

**Citation:** Rowe, P. G.; Chung, Y.

Metabolic Aspects of Rural Life and Settlement Coexistence in China.

*Agricultural & Rural Studies*, 2024, 2, 0007.

<https://doi.org/10.59978/ar02020007>

Received: 3 April 2024

Revised: 22 April 2024

Accepted: 6 May 2024

Published: 24 May 2024

**Publisher’s Note:** SCC Press stays neutral with regard to jurisdictional claims in published maps and institutional affiliations.



**Copyright:** © 2024 by the author(s). Licensee SCC Press, Kowloon, Hong Kong S.A.R., China. The article is an open access article distributed under the terms and conditions of the Creative Commons Attribution (CC BY) license (<https://creativecommons.org/licenses/by/4.0/>).

**Keywords:** metabolism; rural life; *desakota* areas; stock flows; Sankey diagrams; environmental performance

## 1. Introduction

Since the onset of the Anthropocene era, global urbanization has placed increasing pressure on natural resources and ecosystems (Doussard et al., 2024; Gao & O’Neill, 2020; Zhong et al., 2023). Within this framework, the concept of urban-rural metabolism assumes a crucial role in deepening our comprehension of the intricate and dynamic relationships among various elements of human settlements and the environment. Urban-rural metabolism, as an interdisciplinary notion, facilitates an examination of how resources within settlements are utilized and waste is generated, alongside the accompanying societal, economic, and environmental challenges. Moreover, it endeavors to delineate how settlements utilize, transform, and discharge flows of materials, energy, and water (Baccini & Bruner, 2012). The concept of settlement metabolism was initially proposed by Abel Wolman as far back as 1965, and since then, there has been a growing inclination towards viewing urban metabolisms as interconnected and cyclical processes, prioritizing resource efficiency over linear models (Lucertini & Musco, 2020; Wang, 2022). This article aims to analyze Chencun Village in the Shunde District of Guangdong, China, as a representative case study of a *desakota* area. The objective is to present findings regarding water, energy, and material flows, while also providing a comprehensive overview of the case study area’s spatial and demographic characteristics, its position within cities, and the physical attributes of the settlement, including building types, land use patterns, infrastructure, and open spaces.

By 2006 and 2007 or thereabouts the world’s population of about 6.7 billion people crossed a threshold of 50 percent urban to 50 percent rural inhabitants by locale, rising to around 56 percent urban in 2023. During this transition, the urban population of China rose from a paltry 13 percent in 1950 to slightly above 56 percent. By 2050 these proportions seem likely to change globally to around 68 percent urban and 32 percent rural (Ritchie, et al., 2024). Presently there are at least four

kinds of settlement coexistence. They are “compact central city areas”, “dispersed city and peripheral areas” sometimes referred to as being suburban, “organic and informal settlements”, and “desakota” areas, particularly in east and southeast Asia. More specifically in the Chinese context desakota settlements or “township-village enterprises” form a significant part of otherwise rural areas. Although becoming more generally urban, as already noted, the number of rural townships remains slightly above 10,000 in number in 2020, though down lower than some 25,000 in 1979. Indeed, this divergence of smaller towns to more normal urban city pathways has been relatively late in coming to China, dating from as recently as 2000 (Kan & Chen, 2021).

The term “desakota” is from the Indonesian “desa” meaning village and “kota” meaning town and was coined by Terry McGee in the 1990s (McGee, 1991). Also, roughly synonymous with “Township-Village Enterprises” in the Chinese context, they have typically happened in Asia and were located at least initially outside peri-urban zones away from convenient daily commuting and often adjacent to arterial roads. Generally, they were and are characterized by relatively high population densities and adjacent intense agricultural development. They differ from rural areas per se because of their more urban living conditions. In China, they occurred primarily during the Reform Period of the 1980s and mostly in coastal areas such as Guangdong Province and they included enterprises usually sponsored by townships and villages. They also often accommodated substantial numbers of migrant workers and so-called “floating populations”. This usually comprised a rentier situation where villagers gained rental income from migrants working nearby in factories or within onsite village enterprises. Over time many of these settlements have become almost literally absorbed into burgeoning urban development, such as in Guangzhou and Shenzhen (Rowe, et al., 2022).

## 2. Materials and Methods

### 2.1. Context

An example of such a settlement coexistence and an urban-rural lifestyle can be found in Chencun Village in the Shunde District of Foshan in Guangdong Province as illustrated in Figure 1. Referred to as *Shuntak* in Cantonese, this district is a county-level city with an urban area of 806 square kilometers and a population of 2.5 million inhabitants. Renowned for various forms of agriculture from the late Ming through the Qing dynasties, it was a center of sericulture and silk production. In fact, the current Chencun Village remains agriculturally productive with a footprint covering much of 60 percent of the overall site with fresh flowers and trees, as depicted in Figure 2. Indeed, the proportional value of agricultural production in China, judging from 2016 data is the highest rate in the world depicted in Figure 3 (Adapted from Ritchie & Rosado, 2023). Also, as shown in Figure 4, the village, covering an area of 131 hectares, takes on a dispersed but contiguous overall planar form, mainly of residences often associated with district level roadways. Adjacent spaces are given over to plant and tree growing, with a large flower market located on Weixin Lou, a major arterial road cutting through the village from east to west. The population of the village is comprised of some 5,000 residents and a “floating population” of another 1,000 or so inhabitants, all across 1,781 residential units. Mostly these inhabitants are housed in three- and four-story dwellings, as depicted in Figure 5, with ground floors occupied by garages or commercial enterprises, particularly along major streets. Generally, the resident community is well off economically and also incorporates some small factory operations making needed hardware, alongside a primary school.

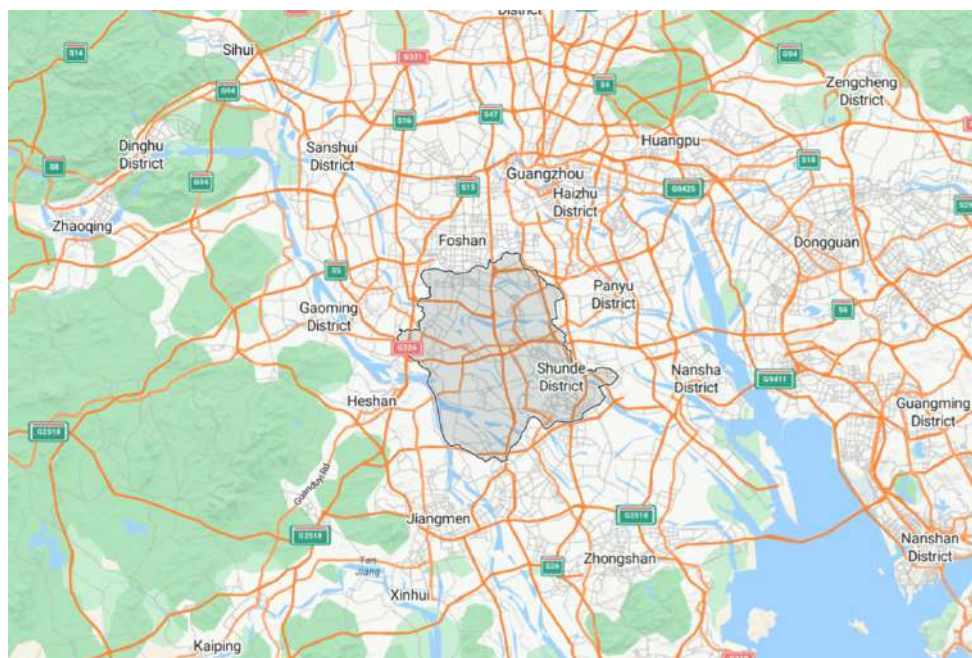

**Figure 1.** The Shunde District in the Context of Guangzhou and Guangdong Province, China.



**Figure 2.** Agricultural Production in Chencun Village, China.

### Value of agricultural production, 2016

Gross production value of the agricultural sector, measured in current US\$.

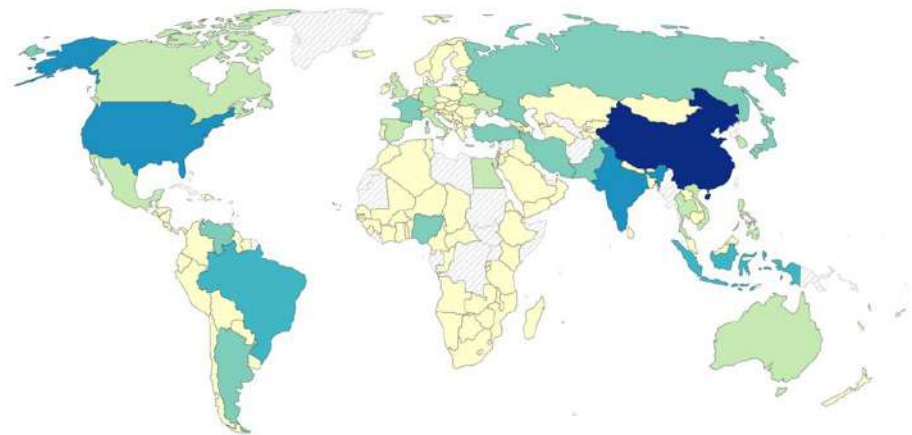

Data source: Food and Agriculture Organization of the United Nations (2024) OurWorldInData.org/agricultural-production | CC BY

**Figure 3.** Worldwide Average of Agricultural Production, 2016. Adapted from “Agricultural Production” by Ritchie H. & Rosado P., 2023, Our World in Data. Data originally sourced from the Food and Agriculture Organization of the United Nations (FAO).

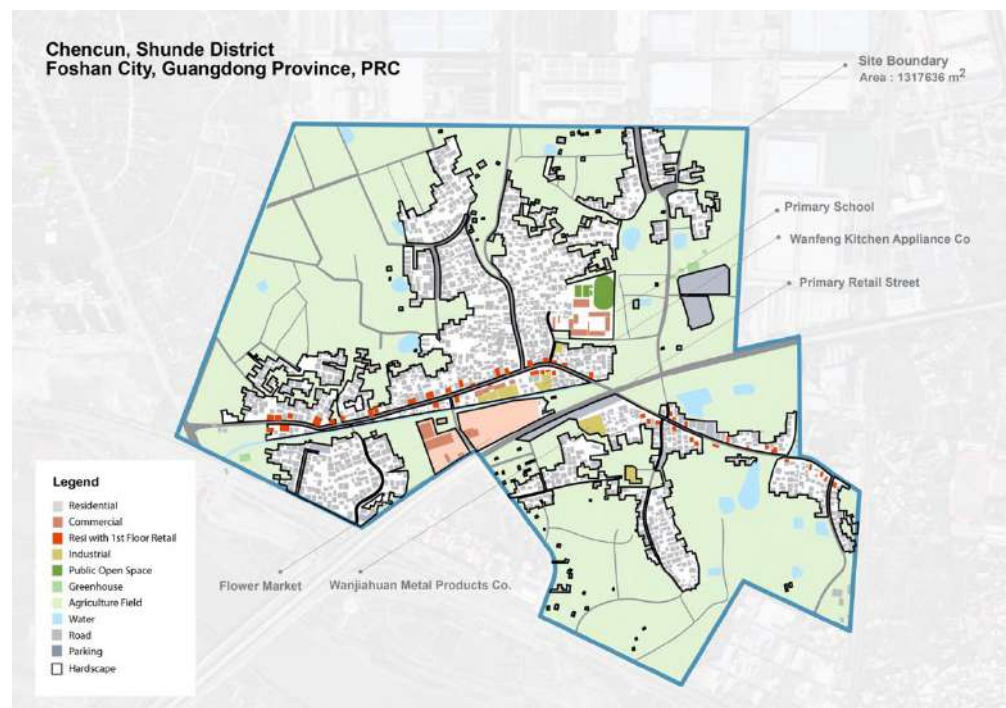

**Figure 4.** The Layout of Chencun Village, China.





**Figure 5.** Residential Buildings in Chencun Village, China.

## 2.2. Model Framing

With the apparent onset of the Anthropocene Era, concern for the metabolism of various kinds of settlement has risen appreciably. This metabolic aspect is manifest in the material from which the settlement is made and how these materials are refurbished and eventually disposed of and recycled, as well as stock flows of water and energy involved. In keeping with much earlier metabolic depictions of life dating back to the 16<sup>th</sup> century and earlier, research resulting in both conservation of mass and energy principles by the 18<sup>th</sup> century, more current accounts were mooted in 1965 by Abel Wolman (Wolman, 1965). Then links between the material character of the natural world and domains like the “Geosphere”, “Biosphere” and “Hydrosphere” could be forged with activities of the “Technosphere”, together with the residuals of spatial settlement production in the form of waste management and recycling potential. This could also be accomplished in a manner that directly reflected temporal variations on processes like deterioration and obsolescence (Baccini & Bruner, 2012). At root metabolism was bound up with the depiction, modeling, and analysis of flows of materials, water, and energy associated with human settlement. In addition, these flows could be conveniently represented through Sankey Diagrams, named after the pioneering work of Captain Sankey in 1898 in explaining the operation of the steam engine (Schmidt, 2008). Read from left to right, the flows of stocks emerge from natural domains and are manufactured into building materials and then deployed within settlement development and finally discarded and/or recycled. The proprietary software SankeyMATIC allows for relatively easy plotting of Sankey diagrams, though with the drawback of not representing circularity easily that needed to be overcome through obsolescence equations.

## 2.3. Data Sources and Interface

Data for the modeling exercises in this article covered at least seven broad categories. They were spatial and population data, construction data, transportation data, information regarding specific stocks of material, data about waste management and recycling, as well as about water and energy use. The types of sources involved were primarily governmental agencies though proprietary sources for particular kinds of materials are also available and relatively reliable. Overall, there were three kinds of data. The first used direct field observation and measurement. This usually concerned information about site uses, some population characteristics, and areas of coverage. Second, there was data specific to a particular locale and within the purview of that locale. For China use was made of available “open data” as well as standardized data sets for built-up areas of the county (Liu et al., 2015; Jiang et al., 2021). Third, there was data relying on proxies drawn from wider surrounding areas such as the city-wide scale. Rarely, if ever, data sources went beyond these levels of spatial resolution. Rough proportions among each of these three categories were around five to ten percent from direct observation, some twenty-five percent from local sources, and the

remainder involving broader proxies. All data, however, was clearly classified as to source, documented, and replicable.

Within each of the three types of stock-flow model depicted in this article, special interfaces have been developed, particularly for facilitation of data input using Excel (v.16.77), each employing a comparable framework and accounting method influenced by material flow analysis (MFA). To create a model of the metabolism of the avenue, mass conservation principle was used where the mass of inputs in a process equals the mass of outputs, plus a storage term (Doussard et al., 2024).  $m$  represents mass, along with equivalent units for energy and water, while time derivatives are indicated by dots.  $p$  and  $q$  denote the summation over input and output terms, respectively.

$$\sum_p \dot{m}_{\text{input}} = \sum_q \dot{m}_{\text{output}} + \dot{m}_{\text{storage}}$$

In the water model, for instance, these include information about the site and occupying population, residential, commercial, and public, as well as industrial and agricultural activities, along with green spaces. For the energy model interfaces apply again to site information and population characteristics, commercial, industrial, agricultural, and transport characteristics. For the material models, categories include site and population, construction of buildings and infrastructure, green spaces, production from agriculture and industry, activities and goods consumption, transport characteristics like various fleets, and waste, including recycling, composting, mining, and waste disposal as depicted in figure 6.

Data		Input
<b>Population</b>		
Number of residents		
Number of households		
<b>Construction</b>		
<b>Buildings</b>		
Floor area collective housing haussmanian buildings and equivalent (m2)		
Building footprint housing haussmanian buildings and equivalent (m2)		
Number of collective housing haussmanian buildings and equivalent		
Floor area collective housing post-1920 buildings (m2)		
Floor area commercial and public haussmanian buildings and equivalent (m2)		
Building footprint commercial and public haussmanian buildings and equivalent (m2)		
Number of commercial and public haussmanian buildings and equivalent		
Floor area commercial and public post-1920 buildings (m2)		
Floor area industrial post-1920 building (m2)		
Floor area agriculture pre-1920 building (m2)		
Building footprint agriculture pre-1920 building (m2)		
Number of agriculture pre 1920 buildings		
Floor area agriculture post-1920 building (m2)		
Life cycle collective housing haussmanian buildings and equivalent (y)		
Life cycle collective housing post-1920 buildings (y)		
Life cycle commercial haussmanian buildings and equivalent (y)		
Life cycle commercial and public post-1920 buildings (y)		
Life cycle industrial post-1920 building (y)		
Life cycle agriculture pre-1920 building (y)		
Life cycle agriculture post-1920 building (y)		
<b>Infrastructure</b>		
Asphalt roads (m2)		
Parking lots (m2)		
Railways rails length (m)		
Life cycle asphalt roads (y)		
Life cycle parking lots (y)		
Life cycle railways rails (y)		
<b>Green Spaces</b>		
Leisure land area herbaceous strata (m2)		
Leisure land area shrub strata (m2)		
Leisure number of trees		
Life cycle trees (y)		
Life cycle shrub strata (y)		
Life cycle herbaceous strata (y)		
<b>Production</b>		
<b>Agriculture</b>		
Production land area herbaceous strata (m2)		
Production land area shrub strata (m2)		
Production number of trees		
Number of bovines		
Number of pigs, sheep and equivalent		
Number of chicken and equivalent		
Organic waste (%)		
<b>Industrial</b>		
Produced plant (t/y)		
Produced animal (t/y)		
Produced aluminum (t/y)		
Produced iron (t/y)		
Produced steel (t/y)		
Produced wood (t/y)		
Produced paper (t/y)		
Produced plastic (t/y)		
Produced glass (t/y)		
Produced rubber (t/y)		
<b>Activities and Goods</b>		
<b>Food and Drinks</b>		
Average consumption of plant based food per capita (kg/y)		
Average consumption of animal based food per capita (kg/y)		
Average consumption of water per capita (kg/y)		
Organic food waste (%)		
<b>Packages</b>		
Average consumption of plastic in packages per capita (kg/y)		
Average consumption of paper in packages per capita (kg/y)		
Average consumption of glass in packages per capita (kg/y)		
<b>Furniture and Furnishing</b>		
Average weight of plastic in furniture per capita (kg)		
Average weight of wood in furniture per capita (kg)		
Life cycle furniture and furnishing (y)		
<b>Consumer and Institutional Products</b>		
Average weight of plastic in consumer and institutional products per capita (kg)		
Average weight of paper in consumer and institutional products per capita (kg)		
Average weight of glass in consumer and institutional products per capita (kg)		
Life cycle plastic consumer and institutional products (y)		
Life cycle paper consumer and institutional products (y)		
Life cycle glass consumer and institutional products (y)		
<b>Clothing</b>		
Average weight of plant products in clothing per capita (kg)		
Average weight of animal products in clothing per capita (kg)		
Average weight of plastic in clothing per capita (kg)		
Average weight of other products in clothing per capita (kg)		
Life cycle of clothing (y)		
<b>Appliances</b>		
Average consumption of steel in major appliances per household (kg)		
Average consumption of plastic in major appliances per household (kg)		
Average consumption of aluminum in major appliances per household (kg)		
Life cycle of appliances (y)		
<b>Transport</b>		
<b>Private Cars Fleet</b>		
Number of cars		
Average weight of steel used per car (kg)		
Average weight of plastic used per car (kg)		
Average weight of aluminum used per car (kg)		
Average weight of rubber used per car (kg)		
Life cycle cars (y)		
<b>Bus Fleet</b>		
Number of buses		
Average weight of steel used per bus (t)		
Average weight of plastic used per bus (t)		
Average weight of aluminum used per bus (t)		
Average weight of rubber used per bus (t)		
Life cycle buses (y)		
<b>Metro Fleet</b>		
Number of metros		
Average weight of steel used per metro (t)		
Average weight of plastic used per metro (t)		
Average weight of aluminum used per metro (t)		
Average weight of rubber used per metro (t)		
Life cycle metros (y)		
<b>Tram Fleet</b>		
Number of trams		
Average weight of steel used per tram (t)		
Average weight of plastic used per tram (t)		
Average weight of aluminum used per tram (t)		
Average weight of rubber used per tram (t)		
Life cycle trams (y)		
<b>Transition</b>		
% of maintenance residential		
% of repurposed residential		
% of demolished residential		
% of maintenance commercial and public		
% of repurposed commercial and public		
% of demolished commercial and public		
% of maintenance industrial		
% of repurposed industrial		
% of demolished industrial		
% of maintenance agricultural		
% of repurposed agricultural		
% of demolished agricultural		
% of maintenance infrastructure		
% of demolished infrastructure		
% of waste produced in repurposed compared to stock		
Maintenance condition residential (H=1; M=0.9; L=0.8)		
Maintenance condition commercial and public (H=1; M=0.9; L=0.8)		
Maintenance condition industrial (H=1; M=0.9; L=0.8)		
Maintenance condition agriculture (H=1; M=0.9; L=0.8)		
Maintenance condition infrastructure (H=1; M=0.9; L=0.8)		
<b>Waste</b>		
<b>Recycling rates (for mined and not mined)</b>		
% paper		
% plastic		
% aluminum		
% iron		
% steel		
% limestone		
% concrete		
% asphalt		
% wood		
% glass		
% clothing		
% rubber		
<b>Industrial collected waste rates</b>		
% industrial waste from organic material (plant + animal)		
% industrial waste from aluminum		
% industrial waste from iron		
% industrial waste from steel		
% industrial waste from wood		
% industrial waste from paper		
% industrial waste from plastic		
% industrial waste from glass		
% industrial waste from rubber		
<b>Composting rates</b>		
% organic waste food		
% organic waste greenspaces		
% organic waste agriculture		
<b>Incinerated rates after sorting</b>		
% paper		
% plastic		
% aluminum		
% wood		
% clothing		
% rubber		
<b>Landfill rates after sorting</b>		
% paper		
% plastic		
% aluminum		
% steel		
% iron		
% concrete		
% limestone		
% asphalt		
% wood		
% clothing		
% rubber		
<b>Export rates after sorting</b>		
% steel		
% iron		
% concrete		
% limestone		
% asphalt		

Figure 6. Material Model Input Interface.

**3. Results and Discussion**

The defining characteristics of the water stock-flow model for Chencun in cubic meters per year without recycling improvements is around two million with a distribution by water source of 33 percent from surface sources and 67 percent from stormwater harvesting reflecting the agriculture associated with the desakota community. The distribution of water use also reflects agriculture at fully 70 percent, followed by 20 percent in residential use and 3 percent on commercial and public use. In this particular case, very little or any use was made of gray water recycling. However, as depicted in Figure 7, with gray water recycling water use is improved by about 12 percent with 25.3 percent coming from surface supply and 62.5 percent from stormwater harvesting. Again, the defining characteristics of energy stock flows reflected the Chinese locale, with 75 percent from fossil fuels of which fully 52 percent was from coal with a further 16 percent of total energy from nuclear, and a paltry 2 percent was from other sources, most likely biomass. This could be readily improved from 4.4 percent renewables to 7.4 percent and a diminution of coal use to 50.8 percent as depicted in Figure 8. Again, agriculture was the major user accounting for 57 percent, followed by related industry at 20 percent, residential at 9 percent and commercial and public use at 3 percent.

Finally, 11 percent was ascribed to transportation again reflecting the rather compact and “stay-at-home” nature of desakota settlement. Improvements in water use could be found in higher levels of gray water use, though the relatively low levels of its primary source in residential use is a constraint. Further shifts towards renewable sources of energy should also be encouraged. Finally, the defining characteristics of material stock-flows in metric tons per year are shown in Figure 9 with fully 85 percent drawn from the Geosphere, 11 percent from the Biosphere, and 4 percent from the Hydrosphere. With regard to land use, most at 85 percent was in residential and agricultural industrial use, including considerable amounts of clay in the pot planting of plants and trees, followed by 6 percent or so in commercial use and 4 percent in transportation. Moderate obsolescence rates meant that 85 percent of material flows remained annually as stock, with some 6 percent ending as collected waste. Of this 78 percent was sorted, 19 percent was otherwise recycled, and 2 percent was composted. Moreover, of the sorted waste fully 89 percent was mined and re-used, a frugality not uncommon to desakota forms of settlement (Cossu & Williams, 2015).

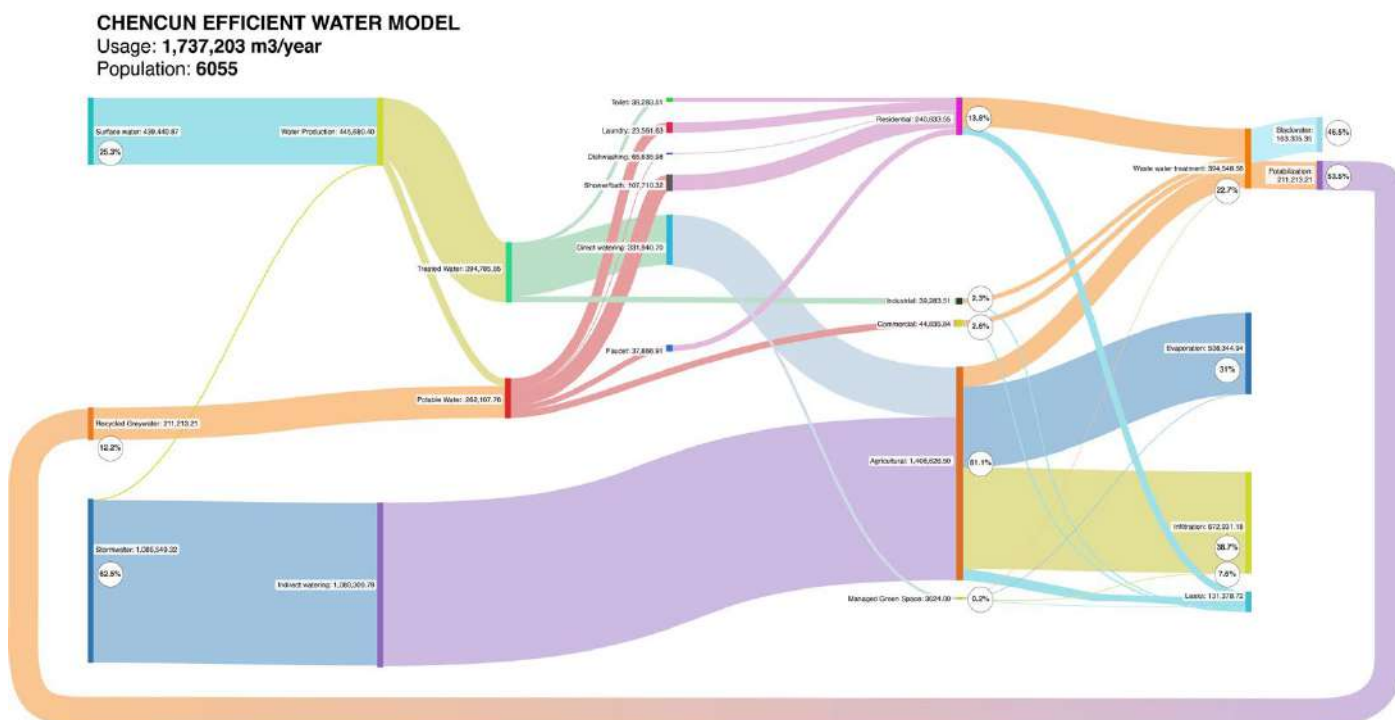

Figure 7. Sankey Diagram of Chencun Efficient Water Model.

# CHENCUN ENERGY EFFICIENT MODEL

Usage: 265,330,593 kWh/year

Population: 6055

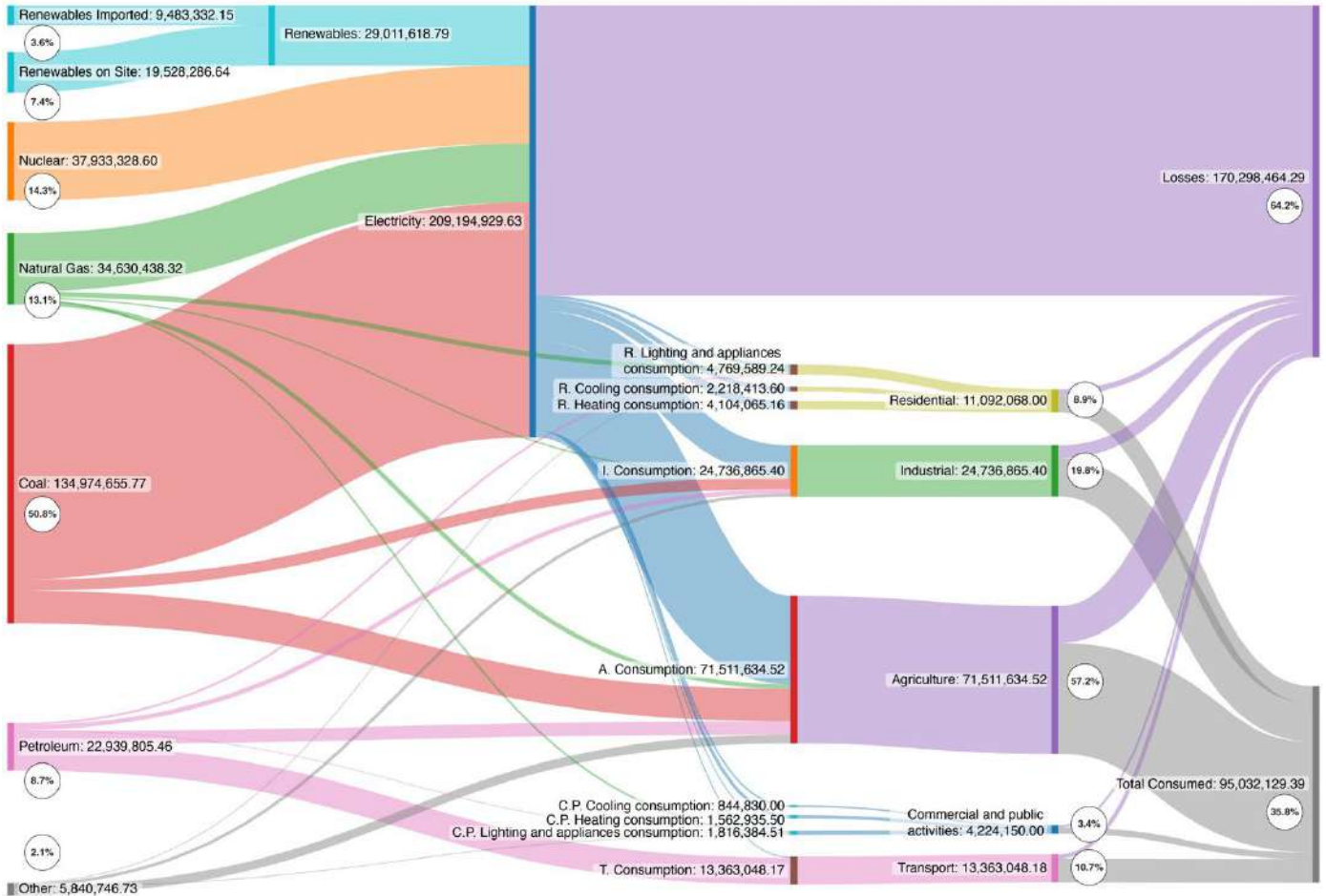

Figure 8. Sankey Diagram of Chencun Efficient Energy Model.

**CHENCUN MATERIAL MODEL**

Usage: 705,961 ton/year

Population: 6055

Lifecycle of buildings: 35 years

Lifecycle of hardscape: 20 years

Lifecycle of roads: 15 years

Lifecycle of parking lots: 50 years

Lifecycle of railway lines: 50 years

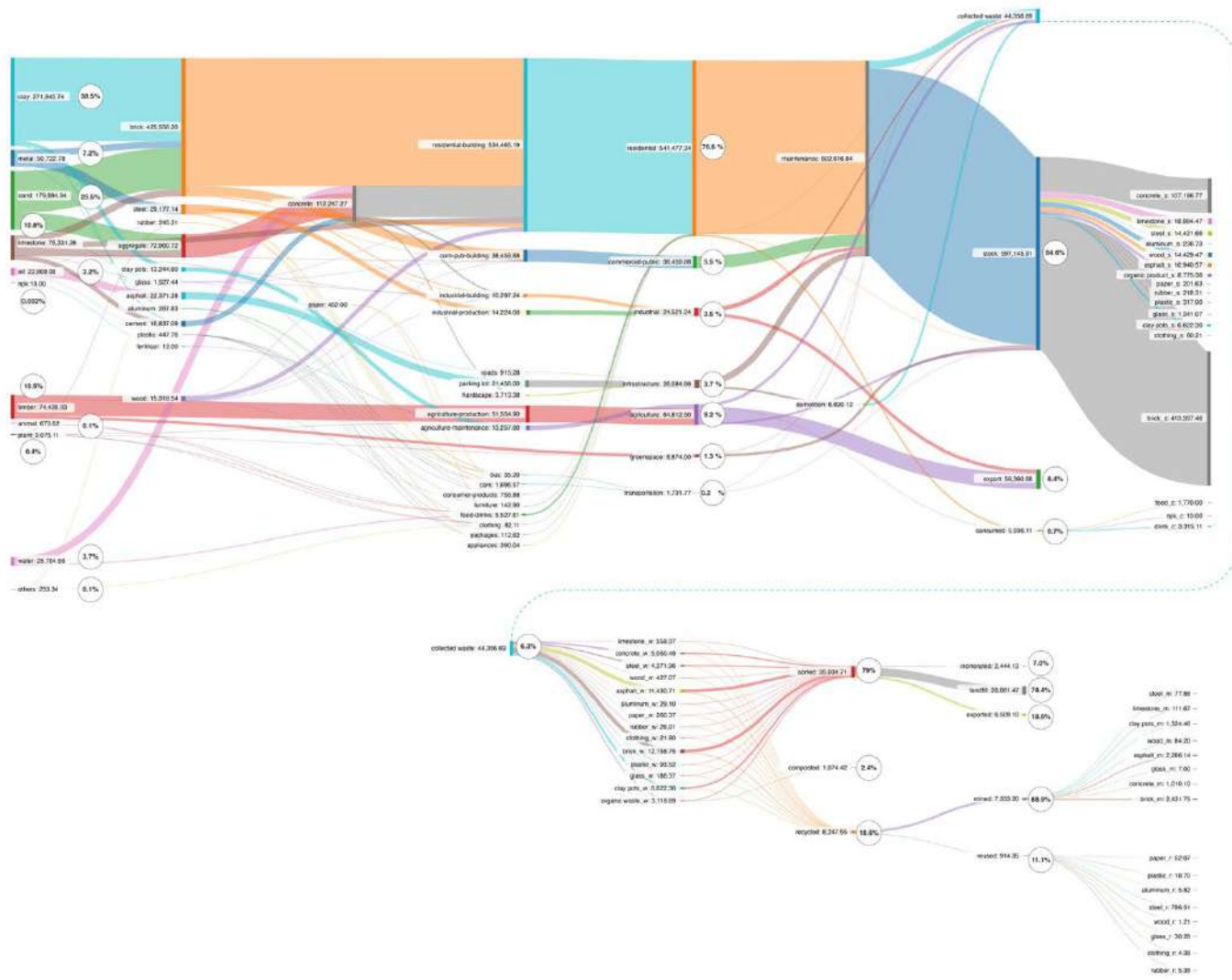

**Figure 9.** Sankey Diagram of Chencun Materials Model.

Compared to other forms of settlement coexistence, desakota areas perform relatively well metabolically and certainly in comparison to less agriculturally developed territories. Setting aside “informal settlement” and their relatively impoverished circumstances, Chencun’s material use is conservative at around 106 metric tons per inhabitant, compared to Paris’ compact inner area development at 117 and the US suburban or peripheral developments wasteful 246 tons per inhabitant. Similarly, applying standard multipliers for embodied energy in MJ/kg/yr. and embodied carbon on KgCo2/kg/yr. averages again show Chencun to be on the low side among other forms of settlement coexistence at around 4.0 or slightly less MJ/kg/yr. compared to Parisian compact forms at around 4.1 and the American peripheral development at 5.8 MJ/kg/yr. Clearly differing obsolescence rates come into play as well, with buildings in the compact example at something like 100 years compared to American peripheral development pegged at around 60 or so years, and somewhat less for Chencun at around 35 to 50 years. Roadway infrastructure by contrast is usually relatively stable at around 15 to 20 years, at least in this modeling analysis. To reiterate, all told Chencun and its desakota style of settlement is relatively conservative from a metabolic perspective. To the extent that improvements might be made they seem to lie in water and waste management, as well as more use of energy renewables as noted earlier. Also, the pursuit of circular functions in

Chencun from the present “cradle-to-grave” configuration to something like, for instance, McDonough and Braungart’s “cradle-to-cradle” biometric mimicking could be attempted further and even for the purpose of becoming a safer stopgap to more rampant compact and peripheral forms of development within China’s emerging Metropolitan Urban Regions (McDonough & Braungart, 2002; Rowe et al., 2022).

**CRedit Author Statement:** Peter G. Rowe: Conceptualization, Supervision, Investigation, and Writing-original draft, Yoeun Chung: Investigation, Visualization, Data curation and Writing – review & editing.

**Data Availability Statement:** Not applicable.

**Funding:** This research was funded by HARVARD CENTER FOR GREEN BUILDINGS AND CITIES.

**Conflicts of Interest:** The authors declare no conflict of interest. The funders had no role in the design of the study; in the collection, analyses, or interpretation of data; in the writing of the manuscript, or in the decision to publish the results.

**Acknowledgments:** Not applicable.

## References

- Baccini, P. & Bruner, P. H. (2012). *Metabolism of the Anthropocene Era: Analysis, Evaluation, Design (2<sup>nd</sup> Edition)*. The MIT Press. <https://doi.org/10.7551/mitpress/8720.001.0001>
- Cossu, R., & Williams, I. D. (2015). Urban mining: Concepts, terminology and challenges. *Waste Management*, 45, 1–3. <https://doi.org/10.1016/j.wasman.2015.09.040>
- Doussard, C., Rowe, P. G., Detavernier, P., & Guo, B. (2024). Metabolism and urban design: Insights from the Champs–Elysées, Paris. *Sustainability*, 16(2), 603. <https://doi.org/10.3390/su16020603>
- Gao, J., & O’Neill, B. C. (2020). Mapping global urban land for the 21st century with data-driven simulations and Shared Socioeconomic Pathways. *Nature Communications*, 11. <https://doi.org/10.1038/s41467-020-15788-7>
- Jiang, H., Sun, Z., Guo, H., Xing, Q., Du, W., & Cai, G. (2021). A standardized data set of built-up areas of China’s cities with populations over 300,000 for the period 1995–2015. *Big Earth Data*, 6(1), 24. <https://doi.org/10.1080/20964471.2021.1950351>
- Kan, K., & Chen, J. (2021). Rural urbanization in China: Administrative restructuring the livelihood of urbanized rural residents. *Journal of Contemporary China*, 31(136), 626–643. <https://doi.org/10.1080/10670564.2021.1985841>
- Liu, X., Song, Y., Wu, K., Wang, J., Li, D., & Long, Y. (2015). Understanding urban China with open data. *Cities*, 47, 53–61. <https://doi.org/10.1016/j.cities.2015.03.006>
- Lucertini, G., & Musco, F. (2020). Circular urban metabolism framework. *One Earth*, 2(2), 138–142. <https://doi.org/10.1016/j.oneear.2020.02.004>
- McDonough, W., & Braungart, M. (2002). *Cradle to Cradle: Remaking the Way We Make Things*. North Point Press.
- McGee, T. G. (1991). The extended metropolis: Settlement transition in Asia. In N. Ginsburg, B. Koppel & T. G. McGee (Eds.), *The Emergence of Desakota Regions in Asia: Expanding a Hypothesis* (pp. 1–26). University of Hawaii Press. <https://doi.org/10.1515/9780824841904-005>
- Ritchie, H., & Rosado, P. (2023). Agricultural Production. Our World in Data. Data adapted from Food and Agriculture Organization of the United Nations. Retrieved from <https://ourworldindata.org/grapher/value-of-agricultural-production>
- Ritchie, H., Samborska, V., & Roser, M. (2024). Urbanization. Our World in Data. Original data from World Bank, 2023, World Development Indicators [Data set]. <https://datacatalog.worldbank.org/search/dataset/0037712/World-Development-Indicators> Processed by Our World in Data. <https://ourworldindata.org/grapher/urban-and-rural-population?time=1960..latest>
- Rowe, P. G., Wang, L. & Z. Chen. (2022). *Chinese Modern: Episodes Backward and Forward in Time*. Birkhauser. <https://doi.org/10.1515/9783035626339>
- Schmidt, M. (2008). The Sankey Diagrams in energy and material flow management. *Journal of Industrial Ecology*, 12(2), 173–185. <https://doi.org/10.1111/j.1530-9290.2008.00004.x>
- Wang, H. C. (2022). Case studies of urban metabolism: What should be addressed next? *Urban Affairs Review*, 59(3), 949–968. <https://doi.org/10.1177/10780874221080145>
- Wolman, A. (1965). The metabolism of cities. *Scientific American*, 213(3), 179–190. <https://doi.org/10.1038/scientificamerican0965-178>
- Zhong, C., Guo, H., Swan, I., Gao, P., Yao, Q., & Li, H. (2023). Evaluating trends, profits, and risks of global cities in recent urban expansion for advancing sustainable development. *Habitat International*, 138. <https://doi.org/10.1016/j.habitatint.2023.102869>

## Article

# Economic Analysis of the Behavior of Prices and Market Arrivals of Tomatoes—A Case Study of West Bengal, India

Sourakanti Sarkar <sup>1</sup>, Sumanta Das <sup>2,3\*</sup>, Suman Dutta <sup>2</sup>, Bimal Bera <sup>1</sup>, Mahadev Bera <sup>2</sup>, Debasish Roy <sup>4</sup>, Md. Mahmudul Hasan Middya <sup>1</sup>, and Malini Roy Choudhury <sup>3</sup>

<sup>1</sup> Bidhan Chandra Krishi Viswavidyalaya, Mohanpur, West Bengal, India; [sourakantisarkar@gmail.com](mailto:sourakantisarkar@gmail.com) (S.S.); [berabk345@gmail.com](mailto:berabk345@gmail.com) (B.B.); [mdmiddya1997@gmail.com](mailto:mdmiddya1997@gmail.com) (M.M.H.M.)

<sup>2</sup> Ramakrishna Mission Vivekananda Educational and Research Institute, Kolkata, West Bengal, India; [sumanta.das@uq.net.au](mailto:sumanta.das@uq.net.au) (S.D.); [duttasumansiliguri@gmail.com](mailto:duttasumansiliguri@gmail.com) (S.D.); [beramahadev1990@gmail.com](mailto:beramahadev1990@gmail.com) (M.B.)

<sup>3</sup> The University of Queensland, St Lucia, Queensland 4072, Australia; [sumanta.das@uq.net.au](mailto:sumanta.das@uq.net.au) (S.D.); [m.roychoudhury@uq.net.au](mailto:m.roychoudhury@uq.net.au) (M.R.C.)

<sup>4</sup> ICAR-Indian Agricultural Research Institute, New Delhi, India; [roydeba93@gmail.com](mailto:roydeba93@gmail.com) (D.R.)

\* Correspondence: [sumanta.das@uq.net.au](mailto:sumanta.das@uq.net.au)

**Abstract:** The oscillations in prices and arrivals of agricultural goods are primarily influenced by the seasonal character of the agricultural production system. Here, we investigate the trends and seasonal price dynamics concerning market arrivals of tomatoes in West Bengal, India. Monthly data on arrivals and prices of tomatoes were collected for the period between 2013–14 and 2019–20. Both the ordinary least square and the twelve-month moving average techniques were employed to identify the long-term trends and seasonal variations in price and arrival patterns. The market arrivals exhibit negative trends in three markets, except for *Barasat* and *Bardhaman*, where the observed values are not statistically significant. However, the lone market in *Diamond Harbour* shows a positive and significant trend in arrivals. Regarding current prices, all markets, except for *Chakdah* and *Siliguri*, exhibit positive and significant trends. Seasonality is more prominent in market arrivals than the price for all the markets. Results suggest the variability in arrivals is proportional to the amount of arrivals in the market, in turn, larger arrivals lead to higher variability. Price variations are substantial and exhibit relative stability both within and across markets, unlike arrivals which show more fluctuation. Price fluctuations are significant not only within a given year but also between different years. Additionally, an inverse relationship between current prices and market arrivals suggests as arrivals increase, prices tend to decrease and vice versa. The study provides new insights into the trends in market arrivals and seasonal price dynamics of tomatoes in West Bengal, eastern India.

**Keywords:** market arrival and trends; tomato prices; ordinary least square; twelve-month moving average; seasonal indices; price dynamics

**Citation:** Sarkar, S.; Das, S.; Dutta, S.; Bera, B.; Bera, M.; Roy, D.; Middya, M. H.; Roy Choudhury, M. Economic analysis of the behavior of prices and market arrivals of tomatoes—A case study of West Bengal, India.

*Agricultural & Rural Studies*, 2024, 2, 2. <https://doi.org/10.59978/ar02020008>

Received: 21 January 2024

Revised: 9 February 2024

Accepted: 30 March 2024

Published: 25 May 2024

**Publisher's Note:** SCC Press stays neutral with regard to jurisdictional claims in published maps and institutional affiliations.



**Copyright:** © 2024 by the author(s). Licensee SCC Press, Kowloon, Hong Kong S.A.R., China. The article is an open access article distributed under the terms and conditions of the Creative Commons Attribution (CC BY) license (<https://creativecommons.org/licenses/by/4.0/>).

## 1. Introduction

The attention of the public has recently been drawn to price changes and projections on the global goods marketplace. The seasonal and perishable nature of agricultural output results in price variations that are significantly greater than those of manufactured products (Paul et al., 2022a; Singh et al., 1993; Tomek & Kaiser, 2014). For the pricing dynamics in the agriculture industry, two historical interpretations have been put up. First, the argument that best fits the framework of rational expectations is that actual shocks including climatic and macroeconomic shocks are what drive prices and second one is that the fluctuations in prices are the result of forecasting errors (Gouel, 2012). Though the explanation of these two theories may lead to the opposite conclusion, are not mutually exclusive. If real shocks affect supply, price adjustment is a natural correction process. Policymakers could want to mitigate their adverse effects on fragile populations, but they should not alter the overall dynamics. If price volatility is caused by a failure to forecast next period market conditions, future scarcity is not driving resource allocation and the state of the economy could be improved through public intervention (Gouel, 2012).

Price volatility in agricultural commodities is caused by several factors, including annual variation in output, low demand price flexibility, and the periodicity of agricultural results (Kahlon & Tyagi, 1983). All variables that produce price changes, whether directly or indirectly, impact the



demand and supply of the commodity. This variation in agricultural product prices has a detrimental impact on farmers' earnings, adding to farm investment instability and, as a result, crop yield (S. A. Patel & J. M. Patel, 2013) the consumer side, this unpredictability in agricultural commodity prices also impacts millions of non-farming people in the nation, particularly the unorganized sectors (Bera, 2017). Because of this, it is difficult for producers and consumers to cope with excessive price swings, especially for small and marginal farmers in developing countries like India who have limited access to effective saving techniques and a low propensity for saving (Sarkar & Bera, 2022).

The Indian economy depends heavily on the agricultural sector, which employs more than 60% of the workforce and generates about 18.50% of the country's GDP (Arjun, 2013; Mondal et al., 2023). Being a state of India, West Bengal is also not an exception in this regard. About 70 percent of the rural population of the state depends on agriculture for their livelihood. There are 71.23 lakh agricultural households in the state, with 96% being small or marginal farmers. The average land-holding is about 0.77 hectares in size (Department of Agriculture, Cooperation & Farmers Welfare, Agriculture Census Division, & Ministry of Agriculture & Farmers Welfare, 2015). As they have very low retention capacity and bargaining strength, they dispose of their produce just after harvesting or during post harvesting period leading to a distress sale (Bhat et al., 2014; Kanungo, 2015). As a result, seasonal indices of prices are high during the lean season when the supply or arrival of the products in the market is low (Asmitaben & Narendra, 2020) i.e., market arrival of a commodity influences the market price of that commodity inversely when other parameters like seasonal demand pattern, competitor presence in the market remain same.

For a long time, a need to have a better understanding of the relationship between price and market arrivals of crops has been urged by many scholars (Naidu, 2014; Sharma & Singh, 2014; Sudhakar Rao & Katkade, 2016). This will help to provide insights into the differences in price across regions since it indicates that not only do consumers pay different prices in different areas for the same products (unless subsidized by programs like PDS), but those producers also receive varied prices depending on their geographical location (Chatterjee & Kapur, 2016; Paul et al., 2022a). Access to price and arrival data also enhances farmers' bargaining power and fosters increased competition among traders by enabling informed decisions, allowing farmers to strategically navigate alternative nearby markets and secure favorable prices for their produce (Paul et al., 2022b). To formulate a good agricultural pricing strategy for price stabilization, a thorough understanding of the interrelationship between market arrivals and farm product prices is required. The market arrival refers to the items available for purchase at a specific location at a specific moment (Prakash, 1995). It can be computed on a year, month, or fortnight basis. To determine the efficacy of a commodity at the local and international level, as well as to draw implications for future pricing and design long-term trade strategies, the most crucial variables are the data about price level, trend, and fluctuations (Chand, 2022). Being originated in the Peru-Ecuador-bolivia area of the Andes, Tomato, a rich source of minerals, vitamins, and healthy organic acids (Thamburaj & Singh, 2001) is one of the major vegetables consumed and produced in India sharing an area of 7.89 percent with a production of 10.68 percent the of total area and production of vegetables grown in India (Department of Agriculture & Farmers Welfare, Directorate of Economics and Statistics, & Ministry of Agriculture & Farmers Welfare, 2021). It acts as a good appetizer and its soup is a useful remedy for patients having constipation (Thamburaj & Singh, 2001). As per the 3rd advance estimate of 2020–21, West Bengal ranked 7th in both area and production of tomatoes among the 10 major tomato cultivating states (Figure 1) of India with a productivity of 21.7 kg/ha (Department of Agriculture & Farmers Welfare et al., 2021).

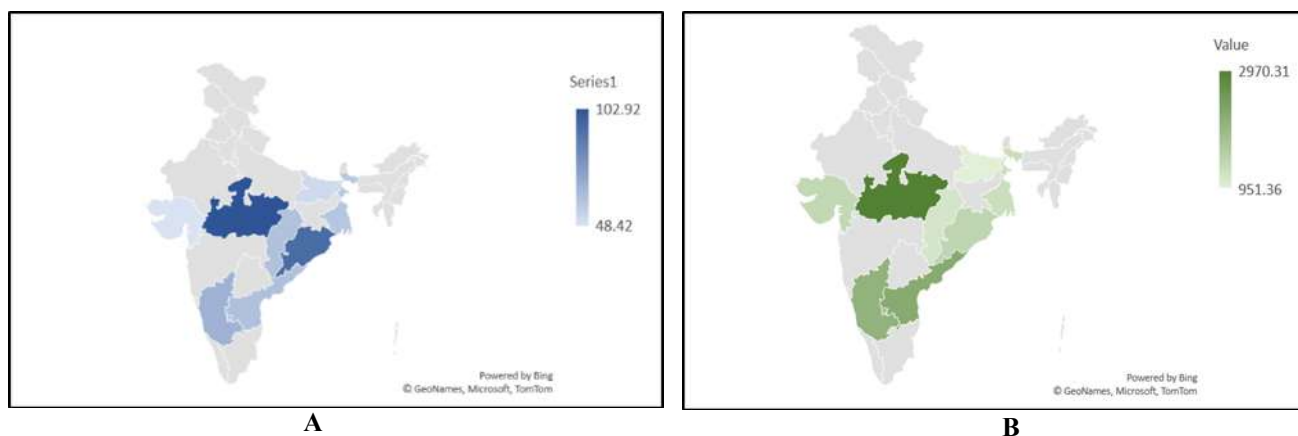

**Figure 1.** (A) Area (in '000 ha) and (B) production (in '000 tonnes) of the top10 tomato cultivating states in India

The vast geographic extent and diverse range of agroclimatic conditions inside the nation significantly impact the availability of the majority of agricultural commodities, particularly vegetable crops, which have shorter growth seasons and a wider ecological range (Kumar et al., 2005). The fluctuation in the output of vegetable crops leads to a wide variation in market price exposing the growers to risk (Sharma, 2011; Singh et al., 2017). Non-availability of institutional support, disease and insect infestation, high cost of seeds, high cost of pesticides, and high cost of labor during peak season are some of the primary limitations found in tomato growing regions (Agarwal & Banerjee, 2019). As a result, output and market arrival fluctuate depending on good and/or bad harvests leading to a wide variation in price. Hence, it is important to understand the volatility and/or variations of market prices across different areas. However, this type of research is very scanty in the study region though it's one of the major tomato-growing and consuming states of India.

In light of the recent extreme price volatility that has affected both producers and consumers and compelled the state government to regulate prices, the goal of this paper is to look into trends in market arrivals and prices as well as to investigate the seasonal price movement concerning market arrivals of tomatoes in West Bengal markets. Overall, this study aims to provide new insights into the trends in market arrivals and seasonal price dynamics of tomatoes in West Bengal in eastern India.

## 2. Materials and Methods

### 2.1. Site Selection and Data Sources

Monthly data on arrivals and prices were collected from a published data source, AGMARK-NET by Govt. of India during the period of 2013–14 to 2019–20. The distribution of markets is done purposively from the different agro-climatic zones of West Bengal. Five different markets viz. *Bardhaman* (Bardhaman District; Vindhyan Alluvial Zone), *Siliguri* (Darjeeling District; Hill Zone), *Chakdah* and *Barasat* (Nadia District; and North 24 Parganas District, respectively; Gangetic Alluvial Zone), and *Diamond Harbour* (South 24 Parganas; Coastal Saline Zone) markets have been selected across the study area (Figure 2).

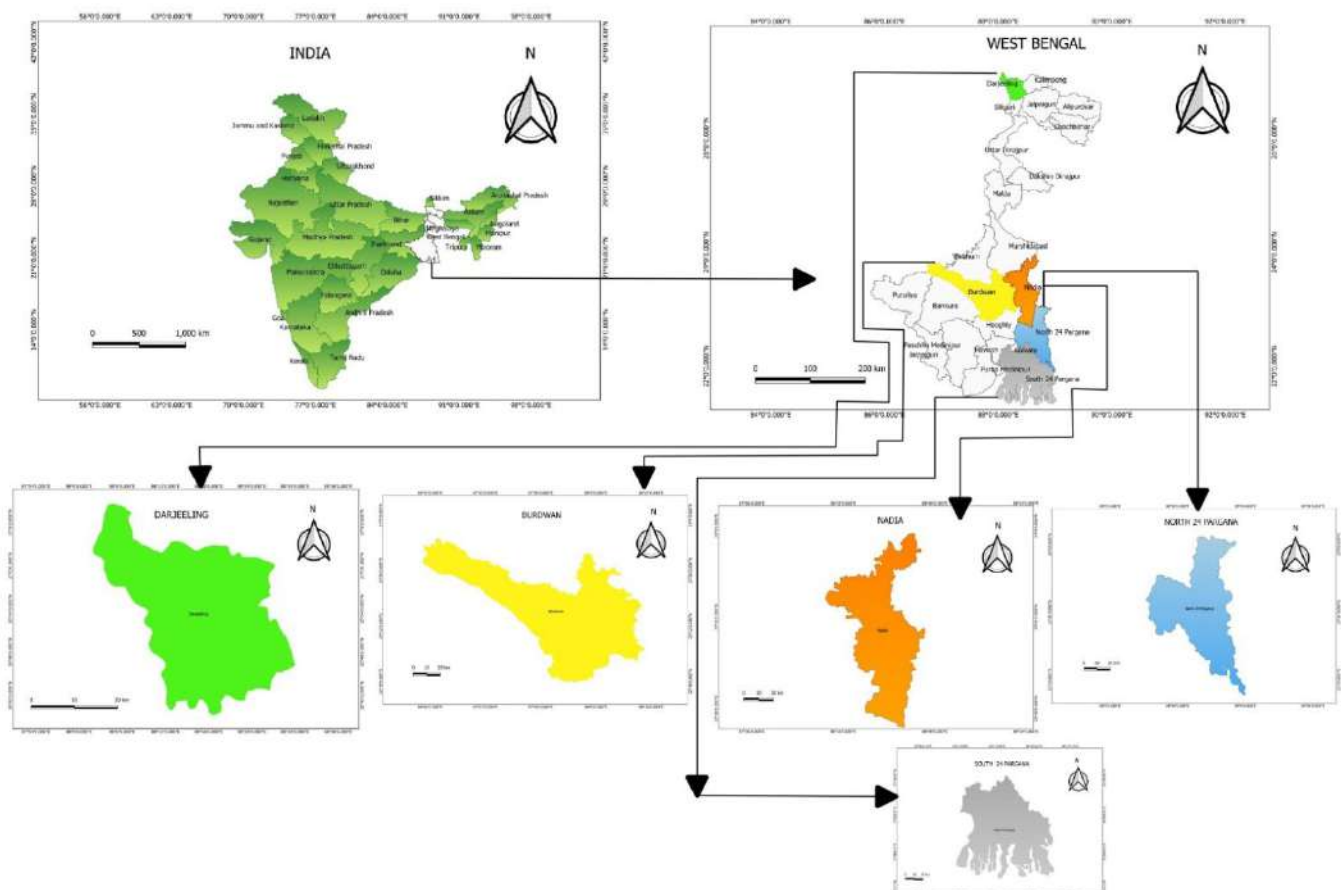

Figure 2. Location map of the study area.

## 2.2. Determining the Trend of Monthly Arrivals and Prices

To estimate the trend of monthly arrivals and prices of Tomatoes in five different markets of West Bengal, the time series data of monthly arrivals and prices are de-seasonalized for adjustment of the seasonal variation by applying of empirical equation (Eq. 1) as proposed by Acharya (2004). De-seasonalized price for the month

$$(SI) = \frac{Y}{T \times C} = \frac{T \times S \times C \times I}{T \times C}, \quad (1)$$

After de-seasonalization, the linear trend is estimated by applying the Ordinary Least Square method of the following form (Eq. 2) (Gujarati, 2021).

$$MA(12) = \frac{1}{12} \times \sum PI, \quad (2)$$

$Y_t$  = Monthly time series data on market arrivals/prices,  $a$  = intercept,  $b$  = coefficient, and  $t$  = time period in month and  $U_t$  = disturbance terms

## 2.3. Statistical Analysis to Estimate Seasonality and Variations of Prices and Arrivals

The twelve-month centered moving average (TMMA) decomposition approach, which provides us with periodic changes without seasonality, is used to calculate seasonal variation (Sarkar & Bera, 2022). To get the seasonal fluctuations, the actual values are divided by the TMMA computed values (Eq. 3).

$$\text{Seasonal Indices (SI)} = \frac{Y}{T \times C} = \frac{T \times S \times C \times I}{T \times C}, \quad (3)$$

Where the letters Y, T, S, C, and I represent the time series data on arrivals and prices, trend components, seasonal variations, cyclical movements, and irregular fluctuations exist in the time series data of arrivals and prices respectively.

Further, to estimate the twelve-month moving average of market arrivals and price indices, we have used the following function (Eq. 4).

$$MA(12) = \frac{1}{12} \times \sum PI, \quad (4)$$

Further, all data related to market arrivals and prices are converted to an index form i.e, multiplied by 100 as given below (Eq. 5).

$$SI = \frac{\sum PI}{MA} \times 100, \quad (5)$$

Where MA (12) = twelve-month moving average which represents  $T \times C$ , PI = market arrivals/price indices, and SI = seasonal indices for market arrivals/prices.

An extra 2-month moving average is computed to center the 12-month moving average (Eq. 6–7). As a result, irregular and seasonal impacts are represented by the ratio to the moving average. The most random influences will generally be minimized if the ratios for each worked over years are then averaged (Acharya, 2004).

$$\text{Adjusted seasonal indices (ASI)} = \text{Seasonal indices} \times \text{correction factor}, \quad (6)$$

$$\text{Correction factor} = 1200 \div \text{sum of seasonal indices}, \quad (7)$$

Further, seasonal monthly arrivals or price index was estimated by applying the function presented as follows (Eq. 8).

$$Si = [(I_h - I_l) / I_l] \times 100, \quad (8)$$

Where  $I_h$  = highest value of the seasonal index and  $I_l$  = lowest value of the seasonal index.

Descriptive statistics followed by an estimation of mean and coefficient of variation (CV) was used to compare month-wise variability in market arrivals and prices of Tomato in the selected markets. By averaging monthly data across years, the impacts of irregular components from monthly time series have been removed and the results are deflated by a correction factor to generate seasonal monthly indices of market arrivals/prices. The amount of intra-year price volatility was estimated using the following techniques (Eq. 9–10), which were further combined with the CV (Eq. 11) (Sarkar et al., 2021).

$$\text{Intra-year price rise (IPR)} = \frac{\text{HSPI} - \text{LSPI}}{\text{LSPI}} \times 100, \quad (9)$$

Where the highest and lowest seasonal price indexes are denoted by HSPI and LSPI, respectively.

$$\text{Coefficient of average price variation (ASPV)} = \frac{\text{HSPI} - \text{LSPI}}{\frac{\text{HSPI} + \text{LSPI}}{2}} \times 100, \quad (10)$$

$$\text{Coefficient of variation} = \frac{\text{STANDARD DEVIATION}}{\text{MEAN}} \times 100, \quad (11)$$

An estimate of Pearson's correlation coefficient ( $r$ ) is required in order to determine the link between market arrivals ( $x$ ) and pricing ( $y$ ) (Eq. 12). The strength of the correlation was compared against a test for significance at 1% ( $p < 0.01$ ) and 5% ( $p < 0.05$ ), respectively.

$$r = \frac{\text{cov}(x,y)}{\sigma_x \cdot \sigma_y}, \quad (12)$$

Where  $\text{COV}(x, y)$  = covariances of  $x$  and  $y$ ,  $\sigma_x$  = standard deviation of  $x$ , and  $\sigma_y$  = standard deviation of  $y$ .

### 3. Results and Discussion

The term "trend" refers to determining the overall direction of a commodity's market arrivals or pricing over several years (Sreepriya & Sidhu, 2015). Table 1 shows the estimated parameters for arrivals and pricing of tomato harvests for *Barasat*, *Burdwan*, *Chakdah*, *Siliguri*, and *Diamond Harbour*. It exhibits that the trend of market arrivals in the first three markets, namely, *Barasat*, *Burdwan*, and *Chakdah* is negative, but significant at the first two markets such as *Barasat* and *Burdwan*, i.e., shows a declining trend., show a declining trend.

**Table 1.** Trend equations for market arrivals and prices of Tomatoes.

Sl. No.	Market	Arrivals ( $Y=a+bT$ )	Price ( $Y=a+bT$ )
1.	Barasat	$Y = 15325.54 - 280.36 * t$	$Y = 1.899 + 1.899 ** t$
2.	Burdwan	$Y = 1254.93 - 12.561 * t$	$Y = 82.78 + 0.241 ** t$
3.	Chakdah	$Y = 106.91 - 228^{NS} t$	$Y = 82.78 + 0.288^{NS} t$
4.	Siliguri	$Y = 102.79 + 0.013^{NS} t$	$Y = 90.94 + 0.302^{NS} t$
5.	Diamond Harbour	$Y = 334.03 + 6.812 * t$	$Y = 2158.95 + 17.627 ** t$

Note: \* and \*\* indicate significance at 1% and 5% levels, respectively and NS refers to statistically non-significant.

The remaining two markets, namely, *Siliguri* and *Diamond Harbour* have experienced increasing trends at the rate of 0.013% and 6.812%, respectively but a positive significant trend was observed only in the *Diamond Harbour* market (Table 1). The positive price trend is recorded in all five markets with varying magnitudes but the results are significant only in *Barasat*, *Burdwan*, and *Diamond Harbour* markets. So, only in one market, i.e., *Diamond Harbour*, the trends are positive in both the market arrivals and price of tomatoes to the tune of 6.81 and 17.63%, respectively (Selvi et al., 2020). Earlier, there was no specific trend concerning arrivals but prices have shown an increasing trend over the years (Keerthi & Naidu, 2013).

The average monthly arrivals are depicted in Table 2. The *Barasat* market is found to be the highest in January (13100 t), followed by February (11810 t) and later by March (9215 t). It shows a downward trend from March to July, and then gradually moves upward and hits the highest point in January month. The average market arrival in January is associated with the highest degree of fluctuation calculated in terms of coefficient of variation (89.26%). Market arrival is highly inflicted with fluctuation ranging from 76.45% in April to 89.26% in January. The *Bardhaman* market has experienced a maximum arrival in March accounting for 1419 t, followed by February (1324 t) and January (1236 t). The market experienced the highest fluctuation rate of 43.96% in January and the lowest fluctuation in April with 33.73%.

**Table 2.** Month-wise variability in market arrivals of Tomato in the selected markets.

Months	Barasat		Bardhaman		Chakdah		Siliguri		Diamond Harbour	
	Mean	CV (%)	Mean	CV (%)	Mean	CV (%)	Mean	CV (%)	Mean	CV (%)
January	13100	89.26	1236	43.96	3961	129.39	3399	108.5	522	101.73
February	11810	87.00	1324	41.90	4414	143.79	3004	103.6	676	132.07
March	9215	79.51	1419	38.51	4791	149.17	3128	115.9	711	120.27
April	6138	76.45	1035	34.50	4179	127.63	3768	146.7	570	96.06
May	5698	77.46	763	33.73	3549	100.23	3232	126.7	571	91.36
June	4815	76.84	683	35.16	2454	73.71	2709	70.60	490	88.54
July	4206	77.39	596	36.76	2509	68.74	2018	64.87	487	86.15
August	4614	79.50	621	38.44	2665	83.97	4105	134.3	485	81.13
September	5186	80.67	565	39.74	3226	71.44	3550	107.1	408	88.29
October	4392	82.03	576	40.47	3353	72.11	3385	100.5	370	66.07
November	4370	84.46	689	40.77	3497	81.75	3283	89.89	427	70.58
December	5355	86.58	889	41.04	4053	109.88	2363	79.50	738	158.09

In the *Chakdah* market of Nadia district, the maximum arrival of 4791 t was recorded in March and gradually declined to the lowest level of 2454 t in June and again started rising for the rest of the periods with small variations across the months. The market has witnessed a major month-wise variation in arrivals ranging from 149.17% to 68.74%, the highest fluctuation of 149.17% is associated with March, and the lowest variability was observed in July (68.74%). Interestingly, the fluctuation in arrivals was positively related to market arrivals, i.e. higher the market arrivals, the higher the variability. The highest amount of average market arrival of 4105 t was recorded in August in the *Siliguri* market of the Darjeeling district with a variability of 134.30%. A gradual deceleration in successive months hit the lowest point of 2018 t in July, though the movement was not smooth across the months. Monthly arrival fluctuation ranges from as low as 64.87% in July to 146.7% in April. The average monthly arrival in the *Diamond Harbor* market was observed to be the highest in December, measuring 738 t with the highest variability of 158.09%, and showed a sudden dip in January and from the next two exhibited an upward movement. From April, it experienced a steady deceleration with slight month-wise variation before it hit the lowest point of 370 t in the lean month of October with the lowest variability of 66.07% and then started rising to reach the maximum level of 711 t in March. The average monthly arrivals in the selected five markets showed broad month-wise variability across the markets, even with the same markets and the peak month of arrival being different for different markets, no definite pattern across all markets over the months was observed.

The average price with associated variability is depicted in Table 3. It reveals that the average prices for tomatoes are the highest in July at Rs. 3196.40/q and changed marginally in each successive month to record the lowest value in March at Rs.1003/q in the *Barasat* market. After hitting the minimum level in March, a growing trend was observed, indicating a definite pattern in the fluctuation of the price of tomatoes in the *Barasat* market i.e., first, a growing pattern from March to July and then a downward movement from July to March. The related monthly volatility varies from 51.28% in September to 54.28% in November. Average prices for tomatoes in the *Bardhaman* market showed up and down movement over the months. In this market, the highest average price level was registered in July accounting for Rs. 4339.29/q to the lowest level in February of Rs. 829.00/q. The variability was recorded as the lowest in September (63.21%) and highest in

February (67.25%), which was eventually associated with the lowest average prices. In this context, it should be noted that though their coefficient of variation, measuring monthly variability was very high, but consistent across the months ranging from 63.21 to 67.25%. The monthly average price in the *Chakdah* market was recorded to be the highest in July amounting to Rs. 3995.40/q and showed a declining trend up to September and there was an upward trend for the next two months till November. From November onwards, there was a gradual deceleration in prices to attain the lowest level in March accounting for Rs. 940.20/q, and again showed an increasing pattern to reach the peak in July. Price in the *Chakdah* market showed wide fluctuation across the months ranging from 39.17% in March to 166.01% in August and there is a positive relationship between price and the associated coefficient of variation across the months. In the *Siliguri* market, the average tomato price was the highest in August with a magnitude of Rs. 3318.60/q, and the corresponding volatility was found to be 179.42% accounting for Rs. 3995.40/q and showed a declining trend up to September. There was an upward trend for the next two months till November. From November onwards, there was a gradual deceleration in prices to attain the lowest level in March accounting for Rs. 940.20/q, and again showed an increasing pattern to reach the peak in July. Price in the *Chakdah* market showed wide fluctuation across the months ranging from 39.17% in March to 166.01% in August and there is a positive relationship between price and the associated coefficient of variation across the months. In the *Siliguri* market, the average tomato price was the highest in August with a magnitude of Rs. 3318.60/q, and the corresponding volatility was found to be 179.42%. The price dropped to the lowest point (Rs. 1137.20/q) in March and the corresponding volatility was calculated to be 52.51%. The average price of tomato in the *Diamond Harbor* market of South 24 Parganas has dropped to Rs. 684.30/q in February after reaching the highest price point in July at Rs. 4467.93/q. The behavioral pattern of average prices is similar to that of the *Chakdah* market with a marginal variation across the months. Maximum price variation was observed in July when consumers in that market witnessed a maximum price and it ranged from as low as 23.48% in February to as high as 164.98% in July. Briefly, the price trend in all five markets is more or less the same across the seasons, from the highest point in the lean season of July or August when arrival is lower and it drops slowly to the lowest level in February or March just after harvest season and then rises upward again to hit the maximum with some minor variation in demand. Month-wise price volatility is wide across the markets, but it is more stable in *Barasat* and *Bardhaman* across the months compared to the remaining three markets, namely, *Chakdah*, *Siliguri*, and *Diamond Harbour* which have experienced large month-to-month fluctuations in the prices of tomatoes. The reason for this greater fluctuation may be due to the seasonality of the agricultural production system and regional specialization arising out of resource endowments including fluctuations in weather conditions.

**Table 3.** Month-wise variability in the price of tomatoes in the selected markets. (Price in Rs. /q)

Months	Barasat		Bardhaman		Chakdah		Siliguri		Diamond Harbour	
	Mean	CV (%)	Mean	CV (%)	Mean	CV (%)	Mean	CV (%)	Mean	CV (%)
January	1079.30	52.63	1273.40	67.09	1487.20	60.40	1652.50	76.11	1398.60	52.53
February	1059.80	52.46	829.00	67.25	977.80	39.09	1146.40	56.03	684.30	23.48
March	1003.40	51.89	2620.00	66.28	940.20	39.17	1137.20	52.51	866.40	32.98
April	1148.00	51.32	1282.60	65.37	1203.80	49.88	1258.40	58.36	1570.20	62.70
May	2222.80	51.53	2477.97	63.95	2474.80	97.77	1515.20	70.74	2485.60	97.72
June	2718.20	51.45	3476.03	63.35	3270.40	135.23	2150.80	100.76	3712.15	147.69
July	3196.40	51.78	4339.29	63.28	3995.40	161.61	3170.40	147.10	4467.93	164.98
August	3074.00	51.86	3533.26	63.28	3482.20	166.01	3318.60	179.42	3879.63	145.37
September	2430.40	51.28	2946.89	63.21	2740.80	113.10	2621.60	120.13	2812.32	109.44
October	2202.20	53.31	3586.30	63.25	3279.80	129.96	2770.40	117.98	3633.20	140.79
November	2466.00	54.28	3350.29	63.26	3446.80	137.42	3000.60	138.51	4024.08	145.66
December	1944.60	53.51	1828.00	63.76	2218.20	83.80	2354.60	103.17	2537.80	85.99

Table 4 details the seasonal market arrival and tomato price indices for these selected markets. This shows that the highest index of market arrivals was found in the *Barasat* market in January (218.33%) and the lowest value was recorded in June (52.26%), and it slowly increased in December (95.37%). A peak arrival index value of 158.48% was recorded in *Bardhaman* in March, followed by February (142.47%), January (130.68%), and December (113.43%). In October, it was the lowest with a value of 69.35%. The *Chakdah* market has witnessed more than 100 indices in the five successive months from December (108.81%) to April (126.39%) and the following seven months have achieved less than 100 indices confirming the lowest in July (68.07%). The peak arrival period was noted in December with a magnitude of 109.84% in terms of the maximum ranking of indices. In the *Siliguri* market, there are six months; January (104.34%), March (111.42%), April (141.04%), May (121.85%), August (129.15%), and September (102.97%) when seasonal indices have exceeded 100%. April has witnessed a maximum seasonal index while July had the lowest (62.35%). Four months in tandem starting from December to March, the *Diamond Harbor* market has maintained more than 100 index values while the highest was observed in December with an index value of 160.72%. In general, for three consecutive months from January to March, all the markets observed more than 100 indices values, except the *Siliguri* sector, which registered less than 100 values in February that could be because the tomato harvesting period in West Bengal starts from this month. In addition to these three months, in three out of five markets, namely, *Bardhaman*, *Chakdah*, and *Siliguri*, the market arrival index value of more than 100% has been extended to other months depending on the farmer's anticipation of higher prices in the future.

**Table 4.** Seasonal indices of market arrivals and prices of Tomato in the selected markets.

Months	Barasat		Bardhaman		Chakdah		Siliguri		Diamond Harbour	
	Arrival	Price	Arrival	Price	Arrival	Price	Arrival	Price	Arrival	Price
January	218.33	55.15	130.68	48.87	128.13	59.73	104.34	74.82	103.43	52.12
February	171.01	54.71	142.74	31.00	142.38	38.66	99.58	55.07	134.27	23.29
March	128.59	46.30	158.48	99.56	147.72	38.74	111.42	51.62	122.27	32.73
April	95.51	53.91	110.42	47.66	126.39	49.33	141.04	57.37	97.66	62.22
May	63.48	114.10	84.34	93.90	99.25	96.68	121.85	69.53	92.88	96.96
June	52.26	134.46	79.71	130.60	72.99	133.73	67.86	99.04	90.02	146.55
July	58.83	153.94	70.96	162.16	68.07	159.82	62.35	144.59	87.58	163.70
August	66.03	147.27	84.94	159.74	83.15	164.17	129.15	176.36	82.48	144.25
September	89.46	122.61	71.59	113.37	70.74	111.85	102.97	118.08	89.76	108.60
October	80.89	130.20	69.35	127.47	71.41	128.52	96.66	115.96	67.17	139.70
November	80.23	96.31	83.37	121.88	80.95	135.90	86.39	136.14	71.76	144.54
December	95.37	91.06	113.43	63.80	108.81	82.87	76.41	101.41	160.72	85.33

The lowest price index value was observed to be 46.30% in March, from which it follows an increasing pattern to reach the value of 100% in May, with small fluctuations in the *Barasat* market. The monthly seasonal index of prices was found to be the strongest in July (153.94%). The seasonal tomato price index of the *Bardhaman* market was the lowest in February (31.00%). Then it increased sharply and reached the maximum of 162.16% in July. The *Chakdah* market's peak seasonal price index was recorded as 164.17% in August and the lowest in February (38.66%). The lowest seasonal price index in the *Siliguri* market was recorded as 51.62% in March and slowly rose upwards in successive months to cross the 100 percentage value in July. Not only that, but held the same for the next five months consistently, while the highest value was noted in August (176.36%). It implies that due to the seasonal and perishable nature of the crops (Tomatoes), wholesale prices were relatively lower during the post-harvest period and very expensive during the lean period (Mishra & Kumar, 2012). The seasonal price index for the *Diamond Harbor* market was the highest in May (163.70 %) and gradually fell to the lowest in February (23.29%).

Further, the magnitude of the intra-year price variance was calculated in terms of the intra-year price rise (IPR), the average seasonal price variability (ASPV), and the coefficient of variation in Table 5. Results indicate that the highest intra-year price was witnessed by the *Diamond Harbour* sector (602.76%) followed by *Bardhaman* (423.04%) and *Chakdah* (324.64%). The lowest intra-year price increase was estimated to be 241.67 and 232.49%, respectively in the *Siliguri* and *Barasat* sectors. On the other hand, the highest and lowest ASPV was estimated in the *Diamond Harbour* and *Barasat* sectors at 37.54 and 26.88%, respectively. The coefficient of variation in prices was maximum in *Diamond Harbour* (46.70%) and minimum in *Barasat* (37.77%).



**Table 5.** Intra-year price rise, average seasonal price variation, and coefficient of variation in the selected markets.

Markets	IPR	ASPV	CV (%)
Barasat	232.49	26.88	37.77
Bardhaman	423.04	33.95	42.07
Chakdah	324.64	30.94	43.86
Siliguri	241.67	27.36	38.13
Diamond Harbour	602.76	37.50	46.70

Theoretically, market arrival is expected to raise the price function while the market price is expected to decrease the market arrival function (Sharma, 2011). The lagged price of tomatoes gave a high response and explained high variation indicating that the lagged price of tomatoes is an important factor in determining the current prices (Mahalle et al., 2014) (Table 6). In the present context, the price of tomatoes is negatively related to the market arrivals in all five markets whereas one year lagged price was positively correlated with the market arrivals in two markets i.e., *Barasat* and *Chakdah* (Table 6).

**Table 6.** Correlation coefficient (r) values between the current prices and market arrivals as well as one-year lagged prices of Tomatoes.

Markets	Correlation Coefficients	
	Current Prices	Lagged Prices
Barasat	−0.10	0.59
Bardhaman	−0.41	−0.67
Chakdah	−0.22	0.74
Siliguri	−0.06	−0.61
Diamond Harbour	−0.073	−0.24

#### 4. Conclusions and Recommendations

To gain perceptions of the trends and seasonal variations of tomato prices in West Bengal, the present study aims to investigate the trends in market arrivals and prices to further determine the seasonal price movement concerning market arrivals of tomatoes in West Bengal. The market arrivals exhibit negative trends in three markets, except for *Barasat* and *Bardhaman*, where the observed values are not statistically significant. However, the lone market in *Diamond Harbour* shows a positive and significant trend in arrivals. Regarding current prices, all markets, except for *Chakdah* and *Siliguri*, exhibit positive and significant trend values. Seasonality is more prominent in market arrivals than the price for all the markets. The variability of arrival is proportional to the amount of arrivals in the market, i.e., the larger the arrival, the higher the variability. Price variations are substantial, although they are more or less steady throughout and within the market as opposed to arrival. In the harvesting or post-harvesting season (February–March), seasonal indices are high for arrival and low for the price, and the reverse is true in the lean season as also reported by Kundu et al. (2019). Price fluctuation is considerable in both within and between years, and the current prices are inversely associated with arrivals. Additionally, the study highlights an inverse relationship between current prices and market arrivals, implying that as arrivals increase, prices tend to decrease and vice versa. The very perishable nature of these veggies, a lack of adequate post-harvest facilities, a lack of scientific storage facilities, or farmers' poor retention capacity for selling their goods in the off-season might be contributing factors to this. Therefore, it is recommended that initiatives be taken to establish a storage structure, the dissemination of market information, a loan facility based on the crop received, and a constant watch on market arrivals and prices to reduce the extent of variability in market arrivals and prices, which is necessary to protect both producers and consumers' interests.

**CRedit author statement:** Sourakanti Sarkar: Conceptualization, Methodology, Software, Data curation, Formal analysis, Validation, Visualization, Writing – original draft; Sumanta Das: Conceptualization, Supervision, Resources, Visualization, Validation, Writing – Review & Editing; Suman Dutta: Writing – Review

& Editing; **Bimal Bera**: Conceptualization, Supervision, Resources, Validation, Project administration, Fund acquisition, Writing – Review & Editing; **Mahadev Bera**: Writing – Review & Editing; **Debasish Roy**: Writing – Review & Editing; **Md. Mahmudul Hasan Middya**: Writing – Review & Editing; **Malini Roy Choudhury**: Conceptualization, Supervision, Visualization, Writing – Review & Editing.

**Data Availability Statement:** Not applicable.

**Funding:** No external funding has been received.

**Conflicts of Interest:** The authors declare no conflict of interest.

**Acknowledgments:** The authors gratefully acknowledge the support of the vice-chancellor of Bidhan Chandra Krishi Viswavidyalaya, West Bengal in conducting this study. In addition, the authors convey sincere thanks to Bhagyashri Chatterjee at Ramakrishna Mission Vivekananda Educational and Research Institute, Kolkata, West Bengal for her great support in handling spatial data and .shp files for the study.

## References

- Acharya, S. S. (2004). *Agricultural marketing in India*. Oxford and IBH Publishing.
- Agarwal, P. K., & Banerjee, A. (2019). Economic analysis of tomato cultivation in Kandi block of West-Bengal, India. *Economic Affairs*, 64(3), 643–647. <https://doi.org/10.30954/0424-2513.3.2019.21>
- Arjun, K. M. (2013). Indian agriculture-status, importance and role in Indian economy. *International Journal of Agriculture and Food Science Technology*, 4(4), 343–346.
- Asmitaben, C. R., & Narendra, S. (2020). Behaviour of market arrivals and prices of cauliflower in selected markets of Gujarat. *International Research Journal of Agricultural Economics and Statistics*, 11(1), 81–86. <https://doi.org/10.15740/HAS/IRJAES/11.1/81-86>
- Bera, B. (2017). A study on the variability in market arrivals and prices of potato in some selected markets of West Bengal. *International Journal of Agriculture Sciences*, 9(40), 4621–4625.
- Bhat, A., Kachroo, J., & Singh, S. P. (2014). A study on behaviour of arrivals and prices of citrus in Narwal market of Jammu, India. *Indian Journal of Agricultural Research*, 48(1), 23–28. <https://doi.org/10.5958/j.0976-058X.48.1.004>
- Chand, R. (2002). *Trade liberalisation, WTO and Indian agriculture: Experience and prospects*. Mittal Publications.
- Chatterjee, S., & Kapur, D. (2016). Understanding price variation in agricultural commodities in India: MSP, government procurement, and agriculture markets. *In India Policy Forum*, 3, 12–13.
- Department of Agriculture & Farmers Welfare, Directorate of Economics and Statistics, & Ministry of Agriculture & Farmers Welfare. (2021). *Agricultural Statistics at a Glance 2021*. Government of India. <https://desagri.gov.in/wp-content/uploads/2021/07/Agricultural-Statistics-at-a-Glance-2021-English-version.pdf>
- Department of Agriculture, Cooperation & Farmers Welfare, Agriculture Census Division, & Ministry of Agriculture & Farmers Welfare. (2015). *All India Report on Agriculture Census (2010–11)*. Government of India. [https://agcensus.da.gov.in/document/ac/air2010-11%20complete\\_compressed.pdf](https://agcensus.da.gov.in/document/ac/air2010-11%20complete_compressed.pdf)
- Gouel, C. (2012). Agricultural price instability: A survey of competing explanations and remedies. *Journal of economic surveys*, 26(1), 129–156. <https://doi.org/10.1111/j.1467-6419.2010.00634.x>
- Gujarati, D. N. (2021). *Essentials of econometrics*. Sage Publications.
- Kahlon, A. S., & Tyagi, D. S. (1983). *Agricultural price policy in India*. Allied Publishers Private Ltd. <https://lccn.loc.gov/83902562>
- Kanungo, S. (2015). Influence of Market Arrival on Price Formation of Turmeric in Kandhamal District of Odisha. *IOSR Journal of Business and Management*, 17(1), 01–05.
- Keerthi, P. K., & Naidu, G. M. (2013). Forecasting monthly prices of tomato in Madanapalli market of Chittoor district. *BIOINFOLET-A Quarterly Journal of Life Sciences*, 10(1b), 201–203.
- Kumar, V., Sharma, H. R., & Singh, K. (2005). Behaviour of market arrivals and prices of selected vegetable crops: A study of four metropolitan markets. *Agricultural Economics Research Review*, 18(2), 271–290.
- Kundu, P., Adhikary, N. K., & Ghosal, A. (2019). Vegetables marketing scenario and trends in prices and arrivals of vegetables in different markets of south 24 Parganas district of West Bengal, India. *International Journal of Microbiology and Applied Science*, 8(12), 1821–1840. <https://doi.org/10.20546/ijemas.2019.812.218>
- Mahalle, S. L., Shastri, S., & Kumar, S. (2014). Behavioural study of market arrivals and prices of pigeon pea in Maharashtra. *Indian Journal of Economics and Development*, 10(1), 86–94. <https://doi.org/10.5958/j.2322-0430.10.1.011>
- Mishra, R., & Kumar, D. A. (2012). Price behaviour of major vegetables in hill region of Nepal: An econometric analysis. *SAARC Journal of Agriculture*, 10(2), 107–120. <https://doi.org/10.3329/sja.v10i2.18332>
- Mondal, M., Paul, S., Mukhopadhyay, A., Mandal, P., Chatterjee, U., Santra, S., Bhattacharya, S., & Paul, S. (2023). Evaluating rural poverty and livelihood diversification in the context of climate-induced extreme events in coastal area: Insights from Indian Sundarban. *Regional Studies in Marine Science*, 67, 103191. <https://doi.org/10.1016/j.rsma.2023.103191>
- Naidu, G. M. (2014). Behaviour of market arrivals and prices of cotton. *BIOINFOLET-A Quarterly Journal of Life Sciences*, 11(4b), 1143–1145.
- Patel, S. A., & Patel, J. M. (2013). A comparative study of arrivals and prices of agricultural commodities at APMC using Time Series Analysis. *International Journal of Advanced and Innovative Research*, 2(4), 778–82.
- Paul, R. K., Yeasin, M., & Paul, A. K. (2022a). The volatility spillover of potato prices in different markets of India. *Current Science*, 123(3), 482–487. <https://doi.org/10.18520/cs/v123/i3/482-487>
- Paul, R. K., Yeasin, M., Kumar, P., Balasubramanian, M., Roy, H. S., Paul, A. K., & Gupta, A. (2022b). Machine learning techniques for forecasting agricultural prices: A case of brinjal in Odisha, India. *Plos One*, 17(7). <https://doi.org/10.1371/journal.pone.0270553>
- Prakash, B., Srivastava, S., & Lal, S. (1995). Market Arrivals and Prices of Urdbeans in Uttar Pradesh. *Indian Journal of Pulses Research*, 8(1), 59.
- Sarkar, S., & Bera, B. (2022). Trend Analysis and Seasonal Variability of Market Arrivals and Prices of Rice in West-Bengal. *Economic Affairs* 67(4), 533–41. <https://doi.org/10.46852/0424-2513.4.2022.19>
- Sarkar, S., Chakraborty, A. J., & Bera, B. K. (2021). Study on behavior of market arrivals and prices of mustard in West Bengal. *Journal of Crop and Weed*, 17(2), 261–266. <https://doi.org/10.22271/09746315.2021.v17.i2.1480>

- Selvi, C. T., Naidu, G. M., Murthy, B. R., & Rajeshwari, S. (2020). Trend and seasonal variation in arrivals and prices of onion in major markets of Tamilnadu. *Andhra Pradesh Journal of Agricultural Sciences*, 6(2), 92–100
- Sharma, R. (2011). Behaviour of market arrivals and prices of tomato in selected markets of north India. *International Journal of Farm Sciences*, 1(1), 69–74.
- Sharma, S., & Singh, I. P. (2014). Behaviour of market arrivals and prices of pearl millet in Rajasthan. *Journal of Rural Development*, 33(3), 351–358.
- Singh, D. K., Pynbianglang, K., & Pandey, N. K. (2017). Market arrival and price behaviour of potato in Agra district of Uttar Pradesh. *Economic Affairs*, 62(2), 341–345. <https://doi.org/10.5958/0976-4666.2017.00018.3>
- Singh, J., Kumari, S., & Grover, D. K. (1993). Behavioral analysis of market arrivals and prices of potato in Punjab. *Agricultural Marketing*, 36(3), 34–42.
- Sreepriya, P., & Sidhu, J. S. (2020). An analysis of Market Arrival and Price Behavior of Potato in India. *Economic Affairs*, 65(1), 9–15. <http://dx.doi.org/10.30954/0424-2513.1.2020.2>
- Sudhakarrao, M. S., & Katkade, J. L. (2016). Seasonality and volatility in arrivals and prices of oilseeds in Marathwada region of Maharashtra state. *Indian Journal of Agricultural Research*, 50(1), 8–14. <https://doi.org/10.18805/ijare.v0i0F.7102>
- Thamburaj, S., & Singh, N. (Eds.). (2001). *Textbook of vegetables, tubercrops and spices*. Indian Council of Agricultural Research.
- Tomek, W. G., & Kaiser, H. M. (2014). *Agricultural product prices*. Cornell University Press.

## Article

# Comparative Study of Agricultural Extension Methods Used by the Public and Private Sectors Before and During COVID-19 Pandemic in Myanmar: A Case Study

Nwaye Ei Khing Phyu \*, Htar Htar Win, Htet Oo Khin , Win Mar Htay, Hein Zaw , Chaw Su Aye, Nyein Nyein Htwe , Sein Lwin Aung, Soe Paing Oo  and Nan Yu Maw

Department of Agricultural Extension, Yezin Agricultural University (YAU), Nay Pyi Taw 150501, Myanmar; 2017-117@yau.edu.mm (H.H.W.); 2017-124@yau.edu.mm (H.O.K.); winmarh460@gmail.com (W.M.H.); 2017-282@yau.edu.mm (H.Z.); chawsuaye6579@gmail.com (C.S.A.); nyeinneyinhhtwe@yau.edu.mm (N.N.H.); minhhtetpaing2012@gmail.com (S.L.A.); soepaingoo@yau.edu.mm (S.P.O.); nanyumaw@yau.edu.mm (N.Y.M.)

\* Correspondence: [nwayeikhingphyu92@gmail.com](mailto:nwayeikhingphyu92@gmail.com)

**Abstract:** Agricultural extension plays a crucial role in the development of the agricultural sector and the dissemination of agricultural information. There are three extension methods, namely individual, group, and mass methods, that facilitate communication between extension workers and farmers. The study was conducted to examine the agricultural extension methods used by the public and private sectors before and during COVID-19 pandemic, and to investigate farmers' preference of agricultural extension methods used by the public and private sectors before and during COVID-19 pandemic in the Zeyarthiri township, Nay Pyi Taw Union Territory. A total of 60 respondents from three villages were interviewed using structured interview questionnaires for quantitative and qualitative data in July 2022. The demographic characteristics, agricultural extension methods received by farmers, and farmers' preference of agricultural extension methods by the public and private sectors were all collected. The descriptive analysis and paired sample t-test were used to compare agricultural extension methods used by both sectors. The Chi-square Friedman test was also conducted to analyze farmers' preference on extension methods with a 5-point Likert scale (1932) before and during the pandemic in SPSS. In terms of farmers' preference, they mostly liked farm and home visits under the individual method used by both sectors among other extension methods in this study area. It indicates that individuals can speak with extension staff members face-to-face during farm and home visits about anything they want to know. During COVID-19 pandemic, the farmers mostly preferred "TV" under the mass method. It means that TV is the best way, not only for COVID-19 restrictions but also for quick access to agricultural information during COVID-19 pandemic.

**Keywords:** agricultural extension methods; farmers' preference; public and private sectors; COVID-19 pandemic

**Citation:** Phyu, N. E. K.; Win, H. H.; Khin, H. O.; Htay, W. M.; Zaw, H.; Aye, C. S.; Htwe, N. N.; Aung, S. L.; Oo, S. P.; Maw, N. Y. Comparative Study of Agricultural Extension Methods Used by the Public and Private Sectors Before and During COVID-19 Pandemic in Myanmar: A Case Study. *Agricultural & Rural Studies*, 2024, 2, 2. <https://doi.org/10.59978/ar02020009>

Received: 15 January 2024

Revised: 12 March 2024

Accepted: 2 April 2024

Published: 26 May 2024

**Publisher's Note:** SCC Press stays neutral with regard to jurisdictional claims in published maps and institutional affiliations.



**Copyright:** © 2024 by the author(s). Licensee SCC Press, Kowloon, Hong Kong S.A.R., China. The article is an open access article distributed under the terms and conditions of the Creative Commons Attribution (CC BY) license (<https://creativecommons.org/licenses/by/4.0/>).

## 1. Introduction

Agriculture is the most important one and is also considered as the backbone economy in the developing countries including Myanmar. In Myanmar, the Ministry of Agriculture, Livestock, and Irrigation (MOALI) has been in charge of the country's agriculture industry since the times of colonization, despite the Ministry's name changing over time (Khaing, 2017). Since it was founded and continues to be so currently, the Agricultural Extension Department has been essential in increasing agricultural productivity ever. The development of a more effective system of agricultural extension relies on adaptable agricultural specialists who are most actively involved in both research demonstrations and the dissemination of the newly appropriate information and technologies to the recipients, such as farmers who live in rural villages, particularly in remote areas in Myanmar. Private and public agricultural extension plays a major role in the capacity building and fulfilling the goals of rural people. Their mission is to support farmers' learning and decision-making regarding improvements to their farming systems, including the use of new technologies, and the handling of issues like food security, poverty alleviation, environmental management, and product marketing.

The Ministry of Agriculture (MOA) set up the Department of Agriculture (DOA) in 1906 because agricultural extension in Myanmar has always received full government support. The MOA had a number of name changes to reflect the goals of the national policy until being restructured as the Ministry of Agriculture and Irrigation (MOAI) in 1996. Among the 14 institutions under MOAI in late 2006, Myanmar Agriculture Service (MAS), Myanmar Farm Enterprise (MFE), Myanmar Jute Industries (MJI), Myanmar Cotton and Sericulture Enterprise (MCSE), Myanmar Sugarcane Enterprise (MSE), etc., are primarily in charge of both the development of technologies and the distribution of suitable agro technologies to the farmers (Oo & Ando, 2012). The only government organization tasked with providing farmers' extension services is the Department of Agriculture (DOA), which is headed by a Director General. Production of seeds, education and training, and research and development (R&D) are its three main duties. The DOA is in charge of transferring the necessary technology through agricultural extension programs (Ponniah et al., 2008). From the perspective of the private sector, for example, different kinds of companies are also expanding their services, which are not limited to seed distributors, pesticide and fertilizer distributors, dealers of other crop management tools, etc., in other countries (Davis & Heemskerck, 2012) and also in Myanmar. The various roles of the private sector were performed as (i) input suppliers and dealers selling pesticides and farm implements; (ii) corporate sector (commercial crops plus farm implements); and (iii) community-based organizations. In addition to providing the technology, input suppliers can participate in agricultural innovations through their networks, share knowledge and perform activities, provide funding, and deliver information (United States Agency for International Development, 2019).

Agricultural extension plays a vital role in disseminating environmentally friendly technology packages, protecting the foundation of natural resources, and improving high-quality production. The extension agents have mostly discussions with rural people to understand more about their problems and to assist them in coming up with appropriate strategies. There are three extension methods, such as 1. individual methods, 2. group methods, and 3. mass methods, to extend knowledge and skills to rural people in the agricultural sector by drawing their attention towards them, arousing their interest, and helping them to have a successful experience of the new technologies and practices. In the individual methods, the extension agent meets the farmer at home or on the farm, explores topics of shared interest, and provides advice and information to them. This method is effective for tasks that each farmer or household can complete on their own or under complete control. Secondly, when using the group method, the agent meets with the group of farmers to conduct extension work. The agent thereby reaches a larger audience than the individual method. For example, group meetings, demonstrations, field days, and tours, etc. Thirdly, mass extension methods involve informing the public through the use of mass media, such as radio, television, newspapers, films, and posters. In general, mass media methods for disseminating agricultural information are helpful in quickly reaching a large audience (Irfan et al., 2006).

In Myanmar, the Ministry of Health and Sports (MOHS) announced the isolation and precautions due to the COVID-19 pandemic for the people starting in March 2020. Therefore, it creates limitations like travel restrictions and a prohibition on public meetings and gatherings that make it challenging for farmers to access agricultural extension services. On the other hand, the agricultural extension personnel frequently lack the mobility to interact with the farmers and supply them with agricultural advice (Talukder et al., 2021). Farmers were faced with a barrier to selling their agricultural products after their harvest from the field, so their income was lower during the pandemic than before. Furthermore, rural families relied on their migratory children; the remittances from the tributaries have been steadily decreasing; and there was a scarcity of labor at the time of sowing (International Food Policy Research Institute, 2021). It is suspected that improper use of teaching methods is making extension services less effective (Umeh et al., 2018). Moreover, the efficiency of extension teaching methods is also influenced by the lack of contact between extension staffs and farmers. (Khan & Akram, 2012). That's why, agriculture and its related sectors must be powerful because they are directly tied to society's most fundamental needs during COVID-19 pandemic. The situation will get worse if the agricultural sector is not resilient enough to handle this pandemic.

Based on the above circumstances, there is a need to prepare for the development of the agricultural sector and its related activities when the outbreak of COVID-19 pandemic stops. Thus, this study focused on the comparative study of agricultural extension methods accessed by farmers that are used among both sectors in the area of Nay Pyi Taw Union Territory. This research was conducted with two objectives, as below:

- (i) To examine the agricultural extension methods used by the public and private sectors before and during COVID-19 pandemic.
- (ii) To investigate farmers' preference for agricultural extension methods used by the public and private sectors before and during COVID-19 pandemic.

## 2. Research Methodology

### 2.1. Study Area

Nay Pyi Taw is the administrative capital of Myanmar, where all ministries are located. There are eight townships in Nay Pyi Taw such as Ottarathiri, Dekkinathiri, Zeyarthiri, Poppathiri, Zabuthiri, Pyinmana, Tatkone, and Lewe. Among them, Zeyarthiri Township (see Figure 1) was chosen as a sample area to evaluate agricultural extension methods used by both sectors because there is the existence of Yezin Agricultural University (YAU), the Department of Agriculture (DOA), the Department of Agricultural Research (DAR), the Agricultural Extension and Rural Development Training Center (AERDTC), and Knowledge centers (KC), which would provide access to agricultural extension activities and improved agricultural technologies. As described in Table 1, there are seven knowledge centers in this township such as 1) Khit Aye, 2) Sipin Tharyar, 3) Kyauk Chat, 4) Aung Zay Ya, 5) Nyaung Pin Gyi Su, 6) Seinzabin, and 7) Kyun Yaung.

**Table 1.** List of knowledge centers (KC) in Zeyarthiri Township.

No.	Knowledge centers (KC)	Number of Farmers
1	Khit Aye	747
2	Sipin Tharyar	1100
3	Kyauk Chat	1103
4	Aung Zay Ya	545
5	Nyaung Pin Gyi Su	675
6	Seinzabin	816
7	Kyun Yaung	1166
<b>Total</b>		<b>6152</b>

Source: DOA, personal communication (2022).



**Figure 1.** Location of study area.

Source: Google Earth.

### 2.2. Data Collection

The field survey was carried out in three villages of Zeyarthiri township, Nay Pyi Taw in July 2022. The structured questionnaire was revised based on the information collected from the pilot survey. Thus, the primary data was collected with the help of a pre-tested interview schedule and a well-structured questionnaire, whereas secondary data (list of knowledge centers) was collected from the Department of Agriculture (DOA), Zeyarthiri township. The township was purposely selected with the factors described in the study area. There were three villages such as Kyun Yaung, Htan Ta Bin, and Thar Yar Su randomly selected from two village tracts (Kyun Yaung and Ma U Taw) in Zeyarthiri township.

The total sample size was collected sixty sample respondents of farmers which were randomly selected with twenty sample respondents from each selected village. The questionnaire of respondents was conducted to collect the following information: demographic characteristics, agricultural extension methods used by both sectors (see Table 2) with the conceptual framework (as in Figure 2), and also farmers' preference for extension methods that are used by both sectors.

### 2.3. Data Analysis

Both qualitative and quantitative data were first input into Microsoft Excel after being collected from a total sample size via an interview schedule. Microsoft Excel was also used to calculate the descriptive analysis and paired sample t-test. Descriptive statistics like mean, percentage, frequency, and standard deviation were used to describe demographic characteristics, and a paired sample t-test was used to evaluate both two different situations, like before and during the pandemic and two different sectors within the same sample of respondents. Thus, a paired sample t-test was chosen to compare agricultural extension methods offered by both sectors (public and private) before and during this pandemic. The analytical techniques were used for the Chi-square Friedman test by SPSS (Statistical Package for Social Science Software) version 25.0. The Chi-square Friedman test was conducted to analyze farmers' preference on extension methods before and during COVID-19 pandemic.

#### 2.3.1. T-Test for 1<sup>st</sup> Objective

The following formula was used to answer the aim of the research, namely the first objective which was to know agricultural extension methods before and during COVID-19 pandemic. This formula used in this study was the Paired sample t-test as below: (Mayesty et al., 2022)

$$t = \frac{\bar{D}}{SD / \sqrt{N}}$$

To get the average difference in measurement 1 and 2, use as below:

$$\bar{D} = \frac{\sum_{i=1}^n d_i}{n}$$

To get the value of the deviation and standard deviation, use as below:

$$SD = \frac{\sqrt{\sum_{i=1}^n (d_i - \bar{d})^2}}{n - 1}$$

where,

**t** = value "t" count

**$\bar{D}$**  = Average difference in measurement 1 and 2

**SD** = Standard deviation of the difference in measurement of 1 and 2

**N** = Number of samples

**$d_i$**  = difference of each pair

**d** = Mean

#### 2.3.2. Chi-square Friedman Test for 2<sup>nd</sup> Objective

The analysis of farmers' preference ranking was calculated by the Friedman's test (Fr.) It can be demonstrated that the statistic Fr. is distributed approximately as chi-square ( $\chi^2$ ) with d.f.= k-1 when the number of rows and/or columns is big (Abeyasekera, 2001).

$$\chi^2 = \sum \frac{(O_i - E_i)^2}{E_i}$$

where,

**$\chi^2$**  = chi-square

**$O_i$**  = observed frequency;

**$E_i$**  = expected frequency;

**$\Sigma$**  = summation sign; and

**k** = category of observation.

(Adie et al., 2021)

The response options ranged from strongly agree = 5, agree = 4, neutral = 3, disagree = 2, and strongly disagree = 1. This type of Likert scale was used to analyze 2<sup>nd</sup> objective.

**Table 2.** Agricultural Extension Methods Used by Public and Private Sectors.

Methods	Types	References
Individual	1. Farm & home visit, 2. Office calls, 3. Phone contacts, 4. Visiting Knowledge Center (KC)	Oakley and Garforth (1985); Buyinza et al. (2009); Khan and Akram (2012).
Group	1. Demonstration, field tour & field visit, 2. Group discussion	
Mass	1. Radio, 2. TV, 3. Pamphlet, 4. Poster, 5. Mobile phone, 6. Facebook, 7. Call center	Irfan et al. (2006); Christopher et al. (2013); Surudhi et al. (2017).

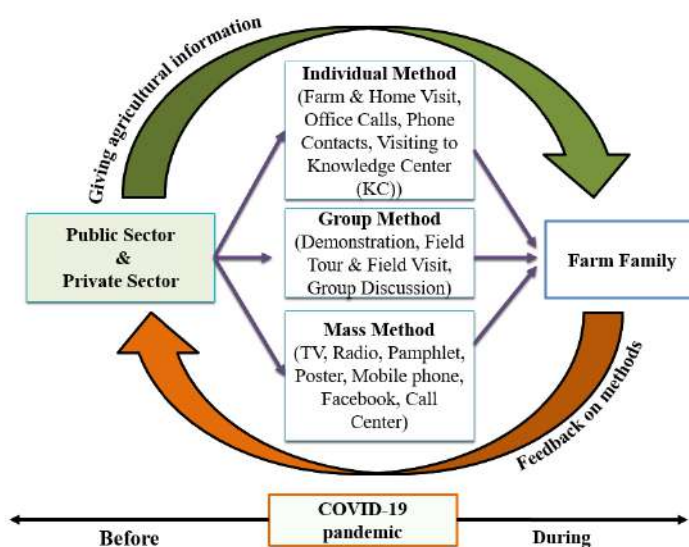

**Figure 2.** Conceptual framework of the research.

**Source:** Authors (2022).

**Note:** Methods adopted from various literature.

### 3. Results and Discussion

#### 3.1. Demographic Characteristics of Sample Farmers

##### 3.1.1. Age

The age of respondents was categorized into three groups: young, middle, and old (shown in Table 3), and their mean age was 50 years, within the range of 21–78 years. The results revealed that most of the respondents are in the middle age group (66.7%), which is between 38 and 63 years old. This was followed by the young age group (18.3%) under 38 years and the old age group (15%) with 64 years and above, respectively. The average age finding is similar to the finding of Thar et al. (2021) in Nay Pyi Taw, Myanmar, where the average age is also 50 years.

##### 3.1.2. Educational Status

The level of education in sample respondents was articulated under these options: graduate, high school, middle school, primary school, monastic education, and illiterate (see Table 3). The result showed that significantly 46.7 percent obtained middle school education. Secondly, 26.7 percent and 18.3 percent attained primary and high school education. Then, it is remarkable that only about 5 percent are monastic education among sample respondents. Moreover, 1.7 percent similarly obtained the ability to read and write, and the graduate level. The level of education can affect the ability to receive knowledge, use new agricultural technologies, and utilize modern ICT (information and communications technology) tools. According to the results, farmers can access agricultural information using ICT tools because their education level is highest at the middle school level. Win and Htwe (2020) found that farmers who possess middle education was the highest percentage (40%) therefore, farmers were able to accept both appropriate agricultural information and appropriate technologies to improve their agricultural productions.



### 3.1.3. Asset of ICT Tools

Information and Communication Technology (ICT) assets are important to receive agricultural information and technology. In this study, the data were collected on the respondents and what kinds of ICT tools they possessed. The assets of respondents on ICT tools include televisions, radios, mobile phones, and laptops (see Table 3). The percentage of respondents who own mobile phones and TVs were 98% and 95% respectively. Only 6.7% of them had laptops, whereas nearly 25% had radios. Thar et al. (2021) reported that the assets of mobile phones had the highest percentage (71%) in Zeyarthiri, Tatkone, and Taungoo townships in Myanmar. Additionally, she found that although farmers in the study area own a high percentage of mobile phones, internet usage is relatively low (38%). Then, Ferris et al. (2008) also found that 86% of farmers had access to a mobile phone, which helped them build connections with others, particularly extension specialists. And then, Abbas et al. (2003) claimed that the mass extension method (presence of TV, radio, etc.) is a crucial source in getting reliable new agricultural technologies for rural communities in Asian countries.

**Table 3.** Demographic Characteristics of Sample Farmers (n=60).

Variables	Respondents	
	Frequency	Percentage (%)
<b>Age (yrs)</b>		
Young group ( $\leq 38$ )	11	
Middle group (38 – 63)	40	18.3
Old group ( $\geq 64$ )	9	66.7
Mean	50	15.0
Std. Dev.	13	
<b>Educational Status</b>		
Able to read and write	1	1.7
Monastic Education	3	5.0
Primary School	16	26.7
Middle School	28	46.7
High School	11	18.3
Graduate	1	1.7
<b>Assets of ICT tools</b>		
TV	57	95
Radio	15	25
Mobile phone	59	98.3
Laptop	4	6.7

Source: Field survey (2022).

### 3.1.4. Farming Experience

The respondents were additionally asked about their individual farming experiences, and their answers were grouped according to how many years of experience they had. The results are shown in Figure 3. In accordance with the results, 25.0% of respondents had 11–20 years of farming experience. 21.7% had between 21 and 30 years as well as between 31 and 40 years of farming experience. Only 18.3% of respondents, or those who had experience below 10 years. Khan and Akram (2012) found that 11–20 years of farming experience was the highest percentage (44%) which is similar to this finding. Although it is described as 11–20 years of farming experience, their farmers were experts in their farming activities because they possessed traditional experience from their ancestors in Pakistan.

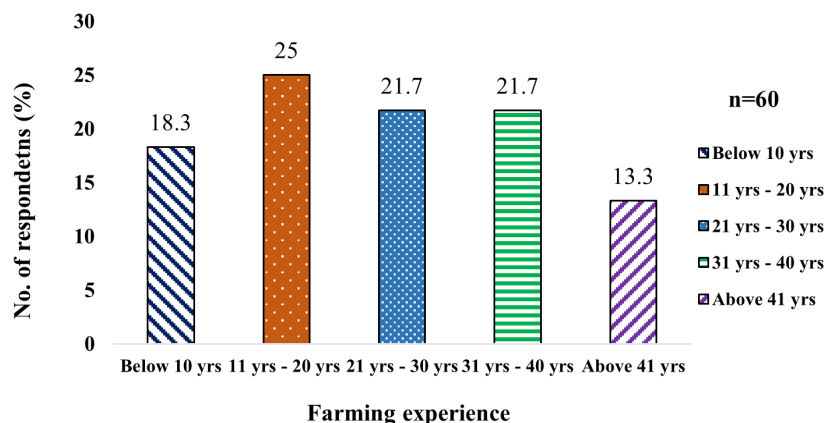

Figure 3. Farming experience of respondents in the study area.

Source: Field survey (2022).

3.2. Access to Field Visit from Public and Private Sectors Before and During COVID-19 Pandemic

According to the public sector, respondents answered “visit” (63.3%) and “no visit” (36.7%) in the same amount both before and during COVID-19 pandemic. The conditions of the field visits to the farmers in this sector remain unchanged. In the private sector, 86.7% of farmers answered “visit”, and 13.3% of farmers answered “no visit” before COVID-19 pandemic. Next, 60% of farmers answered “visit”, and 40% of farmers answered “no visit” in the private sector during the pandemic. Thus, there have been slightly significant changes in the conditions of field visits by the private sector to the farmers (see Table 4 & 5).

As in Table 4, there was a high significance in two sectors before COVID-19 period. It can be assumed that both sectors have no barriers to disseminate their agricultural information but there was no significant in during COVID-19 between both sectors. Thus, there was an alternative calculation to know whether each sector was significant or not in these two periods as shown in Table 5. As a result, the role of the private sector was more distinct than that of the public sector both before and during COVID-19. In Pakistan, Talib et al. (2017) found that private extension services were more effective than public extension services in most aspects.

Table 4. Differences Between Public and Private Sectors in Accessing Field Visits Before and During COVID-19 Pandemic (n=60).

Categories	Before				During			
	Public		Private		Public		Private	
	F	%	F	%	F	%	F	%
No Visit	22	36.7	8	13.3	22	36.7	24	40.0
Visit	38	63.3	52	86.7	38	63.3	36	60.0
<b>t-value</b>	<b>-2.96**</b>				<b>0.31<sup>ns</sup></b>			

Source: Field survey (2022).

Note: F=frequency. t-value, ns, and \*\* represent not significant, significant at 5%.

Table 5. Differences Between Before and During COVID-19 Pandemic in Accessing Field Visits of Each Sector (n=60).

Categories	Public				Private			
	Before		During		Before		During	
	F	%	F	%	F	%	F	%
No Visit	22	36.7	22	36.7	8	13.3	24	40.0
Visit	38	63.3	38	63.3	52	86.7	36	60.0
<b>t-value</b>	<b>0.00<sup>ns</sup></b>				<b>4.63**</b>			

Source: Field survey (2022).

Note: F=frequency. t-value, ns, and \*\* represent not significant, significant at 5%.

Moreover, the frequency of visits per month in the public sector and the private sector most occurred at least once before and during COVID-19 pandemic in comparison with how many visits to the farmers (see Table 6). Before Covid-19, the comparison of visit percent in both sectors are nearly the same to receive agricultural information. Moreover, the percentage of once and twice visits is not quite different during COVID-19. But significantly, the private sector had thrice visits per month, with 11.1% compared to the public sector during COVID-19 with no respondents in the public sector.

Based on this finding, farmers rarely received information from the public sector during the pandemic because a respective extension agent per area can only provide services to them at a fortnightly interval in a month. In these conditions, the private sector is visited more frequently than the public sector because the agents of the private sector are getting more incentives than agents of the public sector, like supporting vehicles and daily allowances in Myanmar. And then, there have been many different organizations, like Myanma Awba, Farm Link, Wisara, etc., in the private sector that have visited the study areas, even though there are few departments like DOA in the public sector. Therefore, Abbas et al. (2021a) reported that several private sector extension organizations (FMC, Jaffer Brother, Arysta Life Science, Bayer Crops, etc.) are present to provide agricultural services to the local farming community. That's why, they frequently contacted the field of farmers or their home one after one in Pakistan.

**Table 6.** Frequency of Visit Per Month from The Public and Private Sectors Before and During COVID-19 Pandemic.

Visit/Month	Before				During			
	Public (n=38)		Private (n=52)		Public (n=38)		Private (n=36)	
	F	%	F	%	F	%	F	%
Once	21	55.3	23	44.2	33	86.8	27	75.0
Twice	12	31.6	22	42.3	5	13.2	5	13.9
Thrice	5	13.1	7	13.5	0	0.0	4	11.1

Source: Field survey (2022).

Note: F=frequency. \* n based on no. of visit from Table 4 and 5.

### 3.3. Comparison of Extension Methods Offered by Public Sector Between Before and During COVID-19 Pandemic

The respondents received different extension methods namely individual, group, and mass methods as shown in Table 7. Based on these group methods (excluding no visit data), 50.0% of respondents received information through the group method, followed by the individual method (36.8%) and the mass method (13.2%) before COVID-19. In normal conditions, farmers were mostly involved in results demonstrations and group discussions in their local villages, which are held by the public sector. Therefore, the group method in comparison had the highest percentage before COVID because farmers could discuss their problems, seek solutions to their farming issues with each other, and also be attracted to community development toward sustainability. Buyinza et al. (2009) stated that most of the farmers in Uganda preferred group methods for disseminating their agroforestry technologies because this method enabled farmers to help each other and motivated them for self-development and empowerment.

On the contrary, 47.4% of respondents received agricultural techniques through the mass method, followed by the individual method (44.7%) and the group method (7.9%) during COVID-19. The mass method among extension methods was potential for the farmers during the pandemic. Therefore, mass methods were especially effective in transmitting agricultural technologies to farmers through communication channels like farmer channels, social media, etc. possessed by the public sector when situations faced not only a limited number of extension staff members but also disasters, pandemics, and other crises. In this case, the percentage of individual methods was also as high as the mass method because farmers used telephone calls during this pandemic to maintain the rules and regulations.

But there is no significant difference in the extension methods used by the public sector before and during COVID-19 pandemic as the result of the t-value. Shanabhoga et al. (2017) described that when there are fewer extension staff members available, telephone calls are a more effective way for the extension personnel in public extension to communicate in normal circumstances. According to Mayesty et al. (2022), the result found a significant difference in extension methods by public sectors during COVID-19 pandemic in Indonesia. This is demonstrated by the way in which extension workers and their target groups hold discussions via social media and other channels among mass methods. There is no specific time to discuss with the extension agent, and they can use it anywhere and anytime when there are several government restrictions that

have led to a lack of direct communication. Moreover, the mass method, as opposed to the group method, which is frequently used by extension agents will significantly increase farmers’ adoption of new technologies and agro-information in Nigeria (Umeh et al., 2018).

3.4. Comparison of Extension Methods Offered by Private Sector Between Before and During COVID-19 Pandemic

According to the private sector (also excluding no visit data), 75% of respondents received information through the group method, followed by the individual method (15.4%) and the mass method (9.6%) before the pandemic. On the other hand, 50% of respondents received information through the mass method, followed by the individual method (36.1%) and group method (13.9%) during the pandemic. There is a highly significant difference among extension methods used by the private sector for the dissemination of agricultural information before and during COVID-19 pandemic in the result of t-value (see Table 7).

Also, the results were the same case with the public sector before and during COVID-19. The group method before COVID-19 was also effective by the private sector because there has more cost-effective in delivering any agricultural information and it could reach medium large number of people in a short period. Abbas et al. (2021a) reported that the private sector paid more attention and used the group method better because it was cost-effective and time-saving. Especially, it tends towards profit-making by reaching a large number of farmers to use their products in Pakistan.

Table 7. Comparison of Extension Methods Offered by Public and Private Sectors Between Before and During COVID-19 Pandemic (n=60).

Categories	Public		Private	
	Before (n=38)	During (n=38)	Before (n=52)	During (n=36)
Individual	14 (36.8)	17 (44.7)	8 (15.4)	13 (36.1)
Group	19 (50.0)	3 (7.9)	39 (75.0)	5 (13.9)
Mass	5 (13.2)	18 (47.4)	5 (9.6)	18 (50.0)
<b>t-value</b>	<b>-0.78<sup>ns</sup></b>		<b>2.56<sup>**</sup></b>	

Source: Field survey (2022).

Note: (1) Figures in the parentheses represent percentage.

(2) t-value, ns, and \*\* represent not significant, significant at 5%.

On the other hand, the mass method was also essential in disseminating information for extension agents and target populations when there is a decrease in individual and group methods due to governmental policies to minimize crowded conditions during COVID-19. Also, Abbas et al., (2021b) stated that this method was cost-effective but it was partially helpful which had to be considered in changing the behavior of farmers. On the other side, they could not sell their products to the farmers compared to other teaching methods because they were more interested in their benefits according to their principles.

3.5. Farmers’ Preference on Extension Methods Before COVID-19 Pandemic

According to the results of the score (see Table 8 & 9), most of the farmers preferred (i) farm and home visit (4.18, individual method), (ii) demonstration, field tour, and field visit (4.12, group method), (iii) group discussion (4.05, group method) and (iv) TV (3.92, mass method), etc. in this study area. Under individual and group methods, they directly acquired agricultural knowledge as well as cutting-edge technologies through face-to-face interactions. They also discussed the difficulties and roadblocks they faced in farming and what they needed from the public sector. The Friedman test was used to determine whether significant differences existed among the extension methods preferred by the respondents. The Friedman test ( $\chi^2 = 167.69$ ;  $p < 0.05$ ) was significant, which meant that significant differences existed.

Okwu and Daudu (2011) reported that crop farmers preferred individual teaching methods (farm and home visit, office calls, and telephone calls) in Benue State of Nigeria because they valued direct communication with extension agents alongside fellow farmers. As the same results of Shaibu et al. (2023), the group method interaction within a group is intended to share ideas, feelings, and actions related to the topic being discussed (adoption of suggested cowpea production techniques) in their cowpea farmers.

**Table 8.** Farmers' preference on all extension methods before COVID-19 pandemic (n=60).

Extension methods	SD	D	N	A	SA
<b>Individual methods</b>					
Farm & home visit	0 (0.0)	1 (1.7)	7 (11.7)	32 (53.3)	20 (33.3)
Office calls	10 (16.7)	29 (48.3)	8 (13.3)	13 (21.7)	0 (0.0)
Phone contacts	1 (1.7)	15 (25.0)	14 (23.3)	27 (45.0)	3 (5.0)
Visiting knowledge centers	1 (1.7)	7 (11.7)	7 (11.7)	36 (60.0)	9 (15.0)
<b>Group methods</b>					
Demonstration, field tour & field visit	0 (0.0)	4 (6.7)	4 (6.7)	33 (55.0)	19 (31.7)
Group discussion	0 (0.0)	3 (5.0)	5 (8.3)	38 (63.3)	14 (23.3)
<b>Mass methods</b>					
Radio	1 (1.7)	11 (18.3)	19 (31.7)	25 (41.7)	4 (6.7)
TV	0 (0.0)	7 (11.7)	6 (10.0)	32 (53.3)	15 (25.0)
Pamphlet	0 (0.0)	4 (6.7)	12 (20.0)	32 (53.3)	12 (20.0)
Poster	0 (0.0)	4 (6.7)	18 (30.0)	27 (45.0)	11 (18.3)
Mobile phone	1 (1.7)	13 (21.7)	14 (23.3)	25 (41.7)	7 (11.7)
Facebook	1 (1.7)	14 (23.3)	12 (20.0)	27 (45.0)	6 (10.0)
Call center	4 (6.7)	16 (26.7)	13 (21.7)	25 (41.7)	2 (3.3)

Source: Field survey (2022).

Note: (1) Figures in the parentheses represent percentage.

(2) SD=strongly disagree, D=disagree, N=neutral, A=agree, SA=strongly agree.

**Table 9.** Mean and Mean Rank of Farmers' Preference on Extension Methods Before COVID-19 Pandemic (n=60).

Extension methods	Types	Mean	Mean Rank
Farm & home visit	I	4.18	8.92
Demonstration, field tour & field visit	G	4.12	8.85
Group discussion	G	4.05	8.58
TV	M	3.92	8.23
Pamphlet	M	3.87	7.92
Visiting knowledge centers	I	3.75	7.50
Poster	M	3.75	7.29
Facebook	M	3.38	6.43
Mobile phone	M	3.40	6.36
Phone contacts	I	3.267	5.9
Radio	M	3.33	5.88
Call Center	M	3.08	5.48
Office calls	I	2.4	3.68
$\chi^2$			<b>167.69**</b>

Source: Field survey (2022).

Note: (1) I (individual method), G (group method), M (mass method)

(2)  $\chi^2$  value, \*\* represent significant at 5%. \*\* = highly accessible.

### 3.6. Farmers' Preference on Extension Methods During COVID-19 Pandemic

During the COVID-19 pandemic, farmers also strongly preferred TV among the mass extension methods (as shown in Table 10 & 11). According to the results of mean value, farmers preferred TV (4.07, mass method), followed by pamphlets (3.83, mass method), posters (3.78, mass method), mobile phones (3.65, mass method), and phone contacts (3.65, individual method), etc. as their mostly preferred extension methods during COVID-19 pandemic. The Friedman test was used to determine whether significant differences existed among the extension methods preferred by the respondents. The Friedman test ( $\chi^2 = 152.67$ ;  $p < 0.05$ ) was significant, which meant that significant differences existed. Nowadays, almost everyone owns a television (TV) in Myanmar. Therefore, they can rely on TV while it broadcasts agricultural information for farmers. It is a very effective way for the farmers who are living in remote areas to cope with sudden restrictions

like this pandemic. TVs have the ability to disseminate information to large audiences efficiently and effectively.

Chhachhar et al. (2012) showed that a large number of respondents believed that television is a useful medium for educating the public about agriculture in the study of Sindh, Pakistan. As a result, the government ought to make effective use of television, particularly its educational programming, to provide the public with important and relevant information. Here, non-governmental organizations and television networks could be extremely helpful to the government in enabling and supporting the realization of this goal.

Syiem and Raj (2015) also reported that TV had the second-highest percentage in the state of Meghalaya, North-East India, which is similar to these findings. Their farmers used ICT tools, especially television (TV), to learn the scientific method of transplanting followed by post-harvest management, in contrast to other agricultural technology. These technologies are frequently shown on the Kissan TV channel of Doordarshan Kendra Shillong (Meghalaya) because they are location-specific and focused on the needs of the state’s farmers.

**Table 10.** Farmers’ Preference on All Extension Methods During COVID-19 Pandemic (n=60).

Extension methods	SD	D	N	A	SA
<b>Individual methods</b>					
Farm & home visit	12(20.0)	17 (28.3)	12 (20.0)	16 (26.7)	3 (5.0)
Office calls	9 (15.0)	27 (45.0)	15 (25.0)	9 (15.0)	0 (0.0)
Phone contacts	0 (0.0)	6 (10.0)	18 (30.0)	27 (45.0)	9 (15.0)
Visiting knowledge centers	3 (5.0)	16 (26.7)	22 (36.7)	18 (30.0)	1 (1.7)
<b>Group methods</b>					
Demonstration, field tour & field visit	1(1.7)	14(23.3)	14(23.3)	18(30.0)	13(21.7)
Group discussion	8(13.3)	15(25.0)	16(26.7)	19(31.7)	2(3.3)
<b>Mass methods</b>					
Radio	2 (3.3)	7 (11.7)	25 (41.7)	24 (40.0)	2 (3.3)
TV	0 (0.0)	4 (6.7)	6 (10.0)	32 (53.3)	18 (30.0)
Pamphlet	0 (0.0)	4 (6.7)	14 (23.3)	30 (50.0)	12 (20.0)
Poster	0 (0.0)	4 (6.7)	17 (28.3)	27 (45.0)	12 (20.0)
Mobile phone	2 (3.3)	6 (10.0)	12 (20.0)	31 (51.7)	9 (15.0)
Facebook	2 (3.3)	9 (15.0)	17 (28.3)	24 (40.0)	8 (13.3)
Call center	2 (3.3)	12 (20.0)	18 (30.0)	27 (45.0)	1 (1.7)

Source: Field survey (2022).

Note: Figures in the parentheses represent percentage. SD=strongly disagree, D=disagree, N=neutral, A=agree, SA=strongly agree.

**Table 11.** Mean and Mean Rank of Farmers' Preference on Extension Methods During COVID-19 Pandemic (n=60).

Extension methods	Types	Mean	Mean Rank
TV	M	4.07	9.44
Pamphlet	M	3.83	8.49
Poster	M	3.78	8.29
Mobile phone	M	3.65	7.92
Phone contacts	I	3.65	7.88
Demonstration, field tour & field visit	G	3.47	7.42
Facebook	M	3.45	7.13
Call Center	M	3.22	6.66
Radio	M	3.28	6.63
Group discussion	G	2.87	5.82
Visiting knowledge centers	I	2.97	5.68
Farm & home visit	I	2.68	5.38
Office calls	I	2.4	4.28
$\chi^2$			152.67**

Source: Field survey (2022).

Note: (1) I (individual method), G (group method), M (mass method).

(2)  $\chi^2$  value, \*\* represent significant at 5%. \*\* = highly accessible.

#### 4. Conclusions

Farmers with middle school level and above can access agricultural information using ICT tools and digital extension programs under the mass method. In Myanmar's education system, English is taught grammatically from Grade 5 to 8 at the middle school level. Because of an understanding of English, it facilitates these tools and makes it easy to learn to use them. As most of the respondents are middle-aged, they can become more familiar with ICT if they are given systematic training to use ICT tools because the mass method involves the use of ICT to increase the rate of adoption of required information by a large number of farmers (Umeh et al., 2018). Farmers possess the highest percentage of mobile phones. Mobile phones created many advantages for the smallholder farmers aside from its unique characteristics of being handy, customized content delivery, and convenience. But mobile phones still have weaknesses such as a lack of familiarity with ICT equipment, a high cost of data, and the fact that not every house is equipped with Wi-Fi. Farmers possess the second highest percentage of TV (non-interpersonal), and it is an old ICT that farmers have been familiar with for a long time and is an easy-to-use tool.

The conditions of field visits from the view of both sectors before and during COVID-19 pandemic, although there are no changes from the public sector to farmers because employees in government sectors have to go to the office on a rotating basis during the lockdown period, highly significant changes were found from the private sector. In the comparison of extension methods offered by both the public and private sectors before and during COVID-19 pandemic, the group extension method was the most widely used method before the pandemic, and although the method of mass extension was less used before the pandemic, it is widely used during the pandemic.

According to farmers' preferences, farmers mostly preferred farm and home visits, demonstrations, field tours, and field visits among individual and group extension methods before COVID-19 because they could discuss individually and had more opportunities with face-to-face discussion about their difficulties and problems encountered in their farming practices. In contrast, farmers preferred TV and pamphlets among the mass extension methods during COVID-19 pandemic. TV plays a significant role in educating farmers about the usage of various pesticides and fertilizers, market information, innovative agricultural techniques, and expert advice. It is the best way, not only for COVID-19 restrictions but also for quick access to agricultural information during COVID-19 pandemic.

Especially since there is the name "Farmer Channel" in the television system under the public sector of Myanmar, it has been released about the agricultural information for the farmers that was started many years ago. TV channels that provide farmers with agricultural formation should develop creative edutainment programs. If TV is one of the extension methods that can help Myanmar's farmers both during restricted situations and receiving electricity regularly, digital extension programs should be improved and also provided to extension personnel in order to disseminate agricultural information through mass extension methods. However, due to the language barrier among farmers, agricultural information should be broadcast on TV channels so that nearly

all farmers can understand it. Therefore, farmers' digital literacy should also be taken into consideration in extension programs.

**CRedit Author Statement:** Nwaye Ei Khing Phyu: Conceptualization, Methodology, Data Curation, Calculation, Software, Validation, Visualization, Investigation, Writing – reviewing, & Editing; Htar Htar Win: Calculation, Writing – reviewing & Editing; Htet Oo Khin: Calculation, Writing – reviewing & Editing; Win Mar Htay: Calculation, Writing – reviewing & Editing; Hein Zaw: Calculation, Writing – reviewing & Editing; Chaw Su Aye: Calculation, Writing – reviewing & Editing; Nyein Nyein Htwe: Supervision; Sein Lwin Aung: Reviewing; Soe Paing Oo: Supervision; Nan Yu Maw: Data collection.

**Data Availability Statement:** Not applicable.

**Conflicts of Interest:** The authors declare no conflict of interest.

**Acknowledgments:** The lead author acknowledges and sincerely thanks everyone who took part in the study as farmers, data collectors, and extension officers in Zeyarhthiri township, Nay Pyi Taw Union Territory. Field-based activities were supported by Daw Nan Yu Maw, Dr. Yi Mon Thu, Daw Ei Thinzar Kyaw, Htar Htar Win, Htet Oo Khin, Win Mar Htay, Hein Zaw, Chaw Su Aye, and Sein Lwin Aung. Prof. Dr. Nyein Nyein Htwe (Head) from the Department of Agricultural Extension, Yezin Agricultural University (YAU), for her kind guidance and helpful suggestions. Dr. Soe Paing Oo from YAU, for his kind support.

## References

- Abbas, M., Sheikh, A. D., Muhammad, S., & Ashfaq, M. (2003). Role of electronic media in the adoption of agricultural technologies by farmers in the central Punjab–Pakistan. *International Journal of Agriculture & Biology*, 5(1), 22–25.
- Abbas, S., Khan, G. A., Shahbaz, B., & Siddiqui, M. T. (2021a). Comparative effectiveness of agricultural advisory services rendered by public and private sectors in the Punjab, Pakistan. *International Journal of Agricultural Extension*, 8(3), 181–188. <https://doi.org/10.33687/ijae.008.03.3377>
- Abbas, S., Khan, G. A., Shahbaz, B., & Siddiqui, M. T. (2021b). Farmers' perspective on the teaching methods used by public and private sectors extension in the Punjab, Pakistan. *Pakistan Journal of Agricultural Sciences*, 58(1), 269–273.
- Abeyasekera, S. (2001). *Analysis approaches in participatory work involving ranks or scores*. <https://www.participatorymethods.org/resource/analysis-approaches-participatory-work-involving-ranks-or-scores>
- Adie, U. B., Ayi, N., & Eya, J. E. (2021). Factors affecting mass media methods of extension delivery system in Yakurr Local Government Area of Cross River State, Nigeria. *Journal of Agriculture, Forestry and the Social Sciences*, 18, 58–72. <https://doi.org/10.4314/joafss.v18i1.8>
- Buyinza, M., Bukenya, M., Bbale, W., & Ndemere, P. (2009). Individual and group extension methods: Perspectives from Vi-Agroforestry project in Masaka district, central Uganda. *Makerere Journal of Higher Education*, 2(1). <https://doi.org/10.4314/majohe.v2i1.46403>
- Chhachhar, A. R., Osman, M. N., & Omar, S. (2012). Role of television in agriculture development of Sindh, Pakistan. *Human Communication*, 15, 1–11.
- Christopher, A., Ariyo, M. O., Okelola, O. E., Aasa, O. S., Awotide, O., Aaron, A. J., & Oni, O. (2013). Assessment of the role of mass media in dissemination of agricultural technologies among farmers in Kaduna North Local Government Area of Kaduna State, Nigeria. *Journal of Biology, Agriculture and Healthcare*, 3, 19–28.
- Davis, K., & Heemskerk, W. (2012). Investment in extension and advisory services as part of agricultural innovation systems overview. In *World Bank, Agricultural Innovation Systems* (pp. 179–259). The World Bank. [https://doi.org/10.1596/9780821386842\\_CH03](https://doi.org/10.1596/9780821386842_CH03)
- Ferris, S., Engoru, P., & Kaganzi, E. (2008). Making market information services work better for the poor in Uganda. *International Food Policy Research Institute*. <https://doi.org/10.2499/CAPRiWP77>
- International Food Policy Research Institute. (2021). *2020 Annual Report* (0 ed.). <https://doi.org/10.2499/9780896294127>
- Irfan, M., Muhammad, S., Khan, G. A., & Asif, M. (2006). Role of mass media in the dissemination of agricultural technologies among farmers. *Journal of Agriculture and Biology*, 8(3), 417–419.
- Khaing, A. A. (2017). *Agricultural extension history in Myanmar*. Department of Agricultural Economics, Yezin Agricultural University. <https://meral.edu.mm/records/1?community=yau>
- Khan, A. R., & Akram, M. (2012). Farmers perception of extension methods used by extension personnel for dissemination of new agricultural technologies in Khyber Pakhtunkhwa: Pakistan. *Sarhad Journal of Agriculture*, 28(3), 511–520.
- Mayesty, A. S., Jamil, M. H., Nadja, R. A., Busthanul, N., Bakri, R., & Thamrin, M. (2022). Extension methods of Pekarangan Pangan Lestari (P2L) Program before and during the Covid-19 pandemic at Parepare City. *International Journal of Environment, Agriculture and Biotechnology*, 7(2), 15–24. <https://doi.org/10.22161/ijeab.72.3>
- Oakley, P., & Garforth, C. (1985). Guide to extension training. *Food and Agriculture Organization of the United Nations*.
- Okwu, O. J., & Daudu, S. (2011). Extension communication channels' usage and preference by farmers in Benue State, Nigeria. *Journal of Agricultural Extension & Rural Development*, 3(5), 88–94.
- Oo, K., & Ando, K. (2012). Improving Myanmar agricultural extension services: Empirical study on views and perception of field extension agents in Mandalay Division of Myanmar. *Kyoto Working Papers on Area Studies: G-COE Series*, 121.
- Ponniah, A., Puskur, R., Workneh, S. W., & Hoekstra, D. (Eds.). (2008). *Concepts and practices in agricultural extension in developing countries: A source book*. International Food Policy Research Institute and International Livestock Research Institute.
- Shaibu, D., Patrick Adejo, E., Shaibu, U., & Haruna, M. (2022). Understanding most preferred extension teaching method in the adoption of agricultural technologies: Empirical evidence from cowpea farmers in Kogi State, Central Nigeria. *International Journal of Agricultural Economics, Management and Development (IJAEMD)*, 10(1). <https://daeksu.com/wp-content/uploads/2022/06/Shaibu-et-al..pdf>
- Shanabhoga, M., Suresha, S., & Dechamma, S. (2017). Impact of public and private agricultural extension on production and income of pomegranate growers. *Journal of Hill Agriculture*, 8(4), 468. <https://doi.org/10.5958/2230-7338.2017.00091.X>
- Surudhi, M., Asokhan, M., & Arunachalam, R. (2017). Utilization Pattern of Extension Tools and Methods by Agricultural Extension Agents. *Journal of Extension Education*, 29(2), 5838. <https://doi.org/10.26725/JEE.2017.2.29.5838-5849>



- Syiem, R., & Raj, S. (2015). Access and usage of ICTs for agriculture and rural development by the tribal farmers in Meghalaya State of North-East India. *Journal of Agricultural Informatics*, 6(3). <https://doi.org/10.17700/jai.2015.6.3.190>
- Talib, U., Ashraf, I., Chaudhary, K. M., & Ahmad, R. (2017). Comparative analysis of satisfaction of smallholder rice growers with public and private extension organizations and development of a strategy to enhance the effectiveness of extension work in the Punjab. *Pakistan Journal of Agricultural Research*, 30(3). <https://doi.org/10.17582/journal.pjar/2017.30.3.242.248>
- Talukder, B., vanLoon, G. W., Hipel, K. W., & Orbinski, J. (2021). COVID-19's implications on agri-food systems and human health in Bangladesh. *Current Research in Environmental Sustainability*, 3, 100033. <https://doi.org/10.1016/j.crsust.2021.100033>
- Thar, S. P., Ramilan, T., Farquharson, R. J., Pang, A., & Chen, D. (2021). An empirical analysis of the use of agricultural mobile applications among smallholder farmers in Myanmar. *The Electronic Journal of Information Systems in Developing Countries*, 87(2), Article e12159. <https://doi.org/10.1002/isd2.12159>
- Umeh, O. J., Aghale, D. N., & Anyim, A. (2018). Assessment of influence of extension teaching methods on the level of adoption of agricultural innovation in Akwa-Ibom State, Nigeria. *International Journal of Advanced Research in Botany*, 4(1), 1–6. <https://doi.org/10.20431/2455-4316.0401001>
- United States Agency for International Development. (2019). *Strengthening Private Sector Extension and Advisory Services—Portfolio Review*. [https://agrilinks.org/sites/default/files/resources/dlec\\_strengthening\\_private\\_sector\\_extension\\_and\\_advisory\\_services\\_full\\_report.pdf](https://agrilinks.org/sites/default/files/resources/dlec_strengthening_private_sector_extension_and_advisory_services_full_report.pdf)
- Win, N. K., & Htwe, N. N. (2020). Farmers' attitude to the effectiveness of ICTs Use in their Farming, Nay Pyi Taw, Myanmar. *Advances in Social Sciences Research Journal*, 7(11), 197–212. <https://doi.org/10.14738/assrj.711.9327>

## Article

# Designing and Analyzing Properties of Socio-Culture and Perception From Livestock Farmers: An Evidence in Utilizing Oil Palm Plantation Land-Use of West Papua

Deny Anjelus Iyai <sup>1,\*</sup>, Ambo Ako <sup>2</sup>, Yubelince Yustenci Runtuboi <sup>3</sup>, Sitti Nurani Sirajuddin <sup>2</sup>, Petrus Abraham Dimara <sup>3</sup>, Budiman Nohong <sup>2</sup>, Amilda Auri <sup>3</sup>, Novita Panambe <sup>3</sup>, Stepanus Pakage <sup>1,\*</sup>, and Nithanel M. H. Benu <sup>4</sup>

<sup>1</sup> Faculty of Animal Science. Papua University. Jl. Gunung Salju, Manokwari. Papua Barat. Indonesia. Postal Code 98314; [da.iyai@yahoo.com](mailto:da.iyai@yahoo.com) (D.A.I.); [s.pakage@unipa.ac.id](mailto:s.pakage@unipa.ac.id) (S.P.)

<sup>2</sup> Faculty of Animal Science. Hasanuddin University. Jl. Perintis Kemerdekaan. Makassar. Indonesia. Postal Code 90245; [ambo.ako@unhas.ac.id](mailto:ambo.ako@unhas.ac.id) (A.A.); [sitti.nurani@unhas.ac.id](mailto:sitti.nurani@unhas.ac.id) (S.N.S.); [budiman.nohong@unhas.ac.id](mailto:budiman.nohong@unhas.ac.id) (B.N.)

<sup>3</sup> Faculty of Forestry. Papua University. Jl. Gunung Salju, Manokwari. Papua Barat. Indonesia. Postal Code 98314; [y.runtuboi@unipa.ac.id](mailto:y.runtuboi@unipa.ac.id) (Y.Y.R.); [p.dimara@unipa.ac.id](mailto:p.dimara@unipa.ac.id) (P.A.D.); [a.auri@unipa.ac.id](mailto:a.auri@unipa.ac.id) (A.A.) [n.panambe@unipa.ac.id](mailto:n.panambe@unipa.ac.id) (N.P.)

<sup>4</sup> Balai Penerapan Standar Instrumen Manokwari. Jl. Susweni. Manokwari, Papua Barat. Indonesia. Postal Code 98314; [thanelbenu@gmail.com](mailto:thanelbenu@gmail.com)

\* Corresponding author: [da.iyai@yahoo.com](mailto:da.iyai@yahoo.com) (D.A.I.); [s.pakage@unipa.ac.id](mailto:s.pakage@unipa.ac.id) (S.P.)

**Abstract:** Socio-culture and perception exist and perceive farmers in achieving optimal benefits have been discussed worldwide by many scholars. However, lack of knowledge and data on specific cases in community-dependent oil palm plantations is available. This study aims to explore and synthesize the roles of socio-cultural properties and perceptions of farmers in utilizing tropical oil palm land use in West Papua. The field research was conducted using the survey method by applying interviews with 118 farmers selected from four districts of Warpramasi lowland valley. The findings show that socio-cultural properties such as age, gender, objectives of livestock rearing, experiences, livestock size as assets, jobs/employment, and years of experience have significant contributions both strong ( $r > 0,50$ )/weak ( $r < 0,50$ ), and positive ( $r > +0,50$ )/negatives ( $r > -0,50$ ) in applying oil palm plantation area. Experiences and ages are shown as an example. Farmers' perceptions of oil palm land use also vary. Local community supports are determined by age, gender, experiences, values, and beliefs. Farmers perceive local community support as one crucial factor that determines the success and sustainable productivity of farming land, economics, and livestock. Improvement of oil palm plantation land use will be achieved its benefit when all parties (stakeholders) will share and contribute to resources needed accordingly.

**Keywords:** socio-cultural productivity; farmer perception; utilization of free-rearing land; oil palm plantations; Manokwari

**Citation:** Iyai, D. A.; Ako, A.; Runtuboi, Y. Y.; Sirajuddin, S. N.; Dimara, P. A.; Nohong, B.; Auri, A.; Panambe, N.; Pakage, S.; Benu, N. M. H. Designing and Analyzing Properties of Socio-Culture and Perception From Livestock Farmers: An Evidence in Utilizing Oil Palm Plantation Land-Use of West Papua. *Agricultural & Rural Studies*, 2024, 2, 2. <https://doi.org/10.59978/ar02020010>

Received: 14 February 2024

Revised: 13 March 2024

Accepted: 20 April 2024

Published: 29 May 2024

**Publisher's Note:** SCC Press stays neutral with regard to jurisdictional claims in published maps and institutional affiliations.



**Copyright:** © 2024 by the author(s). Licensee SCC Press, Kowloon, Hong Kong S.A.R., China. The article is an open access article distributed under the terms and conditions of the Creative Commons Attribution (CC BY) license (<https://creativecommons.org/licenses/by/4.0/>).

## 1. Introduction

Palm oil plantation in the tropical land use of Indonesia contains various interaction of utilization. Several oil palm plantations exist in several provinces in Indonesia. The one is in West Papua provinces. For community-dependent oil palm, parameters of socio-cultures and perception are established for a length of time. Productivity and farmers' perceptions regarding the use of open land in oil palm plantation areas can be influenced by several factors (Sudirman et al., 2021). Socio-cultural productivities include social activities and interactions in a society that can influence the results and quality of work and daily life. In the context of utilizing open land in oil palm plantation areas, the following socio-cultural factors will affect productivity such as age, gender, objectives, experiences, and occupancies, including collaboration and togetherness. The level of cooperation between farmers and oil palm plantation companies will benefit farmers and the productivity of resources such as land, plants, and livestock. The good collaboration between farmers and plantations is created by providing available palm oil land for free-rearing livestock, planting forages, and includes community empowerment such as effective training and mentoring programs. In turn, the perception of the local community, farmers, and other stakeholders including local government

will positively improve. In this case, sociocultural productivity and the perception of the farmers in particular are shaped by mutual cooperation.

The level of skills and knowledge of farmers (Ediset et al., 2017; Praza, 2016) in managing open land and running livestock businesses will have an impact on productivity. Since the operation of the oil palm plantation in West Papua in 1987, little is known concerning the socio-culture and perception performances of the present plantation. Farmers with their socio-culture traits such as age, gender, jobs, and experience are contributing to accelerating better utilization of oil palm land use provided by the company for a length of time. Mutual and positive cooperation between the company and land owners including farmers will have consequences for the sustainable oil palm company and its land.

Farmers' perceptions refer to farmers' understanding, views, feelings, values, and attitudes (Kauber et al., 2017; Kauppinen et al., 2013; Shikuku et al., 2017). This case is regarding the use of open land in oil palm plantation areas. This perception can have an impact on farmers' actions and productivity. Several factors that cause farmers' perceptions are economic benefits (Cortner et al. 2019; Paris, 2002). It occurs when farmers have access to, see, and experience significant economic benefits. Rearing livestock in free ranges under the canopy of palm oil trees, growing forages and edible livestock plants will aid direct benefit. In turn, they tend to have a positive perception of the land use of palm oil plantations. As consequences, farmers will save and protect land and resources from environmental degradation (Kauppinen et al., 2013). The negative impact of environmental damages will be reduced. Therefore, in this study, we are eager to evaluate and assess how performances of socio-culture and farmers' perceptions (Boogaard, 2009; Mukhopadhyay, 2009) shaped and worked under this mutually interlinked process.

The application of multivariate analysis is rarely presented on these two properties, i.e. socio-culture and perception concerning the benefit of oil palm land use in this region and under the tropical setting of Indonesia. The application of the correlation matrix and the principal component will enable scholars and policy makers to assess the strengths and weaknesses of the relationships of applied parameters. For policy makers, intervention will be designed and implemented for improving this connectivity.

The support from plantation corporations, government, or other institutions can also affect farmers' perceptions (Campos et al., 2014; Ediset et al., 2017; Sekaran et al., 2021). Once farmers feel supported in developing livestock businesses under palm oil open land, they are more likely to have positive perceptions and contribute to livelihood productivities. The aim of this study is to synthesize and explain the level of farmer productivity which is influenced by socio-cultural aspects and farmer perceptions.

## 2. Materials and Methods

### 2.1. Sampling Location

Manokwari Regency is divided into 9 districts, with a total area of 4650.32 km<sup>2</sup>. Manokwari Regency with its 9 districts is astronomically placed below the equator, between 0°14' S and 130°31' E. The geographical boundaries of Manokwari Regency are in the West bordering Tambrauw Regency, in the North bordering the Pacific Ocean, in the East is the Pacific Ocean, and to the south is the Arfak Mountains Regency and South Manokwari (Figure 1). Sample locations from the review and field research were taken from the four districts in Manokwari district, West Papua, i.e. Warmare, Prafi, Masni, and Sidey.

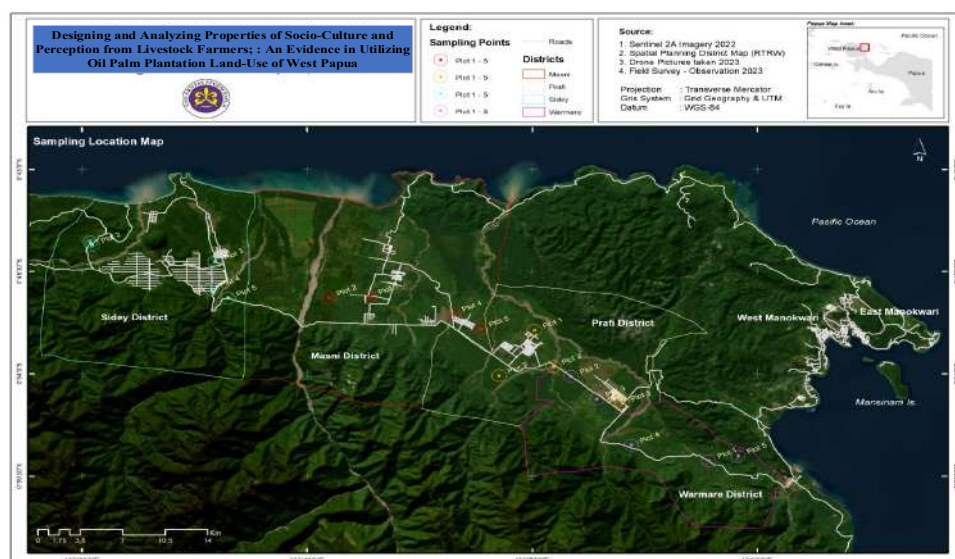

**Figure 1.** Spatial map of research sites at four districts, Warmare, Prafi, Masni, and Sidey.

The basic selection of these areas is by the reason that these areas have been widely used for several types of land-uses, namely plantations, transmigration areas, fertile land, communal land, and as a livestock production center in Manokwari. The total study area is 1,022.67 km<sup>2</sup> (102,266.54 ha). In general, the profile of the study area consists of coastal areas, lowland areas, and highland areas. The precipitation conditions are clear between the wet months (rain) and the dry months based on information from BMKG Manokwari Regency data, namely the wet months are from December to May (6 months) for 221 days with rainfall of 287.4 mm<sup>2</sup>. Meanwhile, the dry months are from June to November (6 months) every year.

**2.2. Methods of Study**

In conducting this study, methods employed were descriptive methods by using techniques of field survey and observation towards farmers and livestock production. In doing the field survey, we designed a semi structure questionnaire ([Appendix](#)).

**2.3. Farmers' Samples**

Determination of farmers' samples was carried out using the Snowball Technique. From the results of respondents' exploration, we reached 118 households of farmers. Table 1 shows the 118 respondents and their proportion in detail of district and village origin.

**Table 1.** Sampling in districts and villages in Warpramasi.

District	Village	Respondent	Proportion (%)
Warmare	5	30	25,42
Prafi	5	30	25,42
Masni	5	28	23,74
Sidey	5	30	25,42
Total	20	118	100

**2.4. Observation Variables**

The variables measured were the farmer age (years/person), gender (male/female), farming goals, farming experience (years/person), and the number of livestock owned for cattle, pigs, goats, ducks, free-range chickens (tails /person) and type of breeder's job (State officers, Army/Police, Farmer, Breeder, and Private), as well as year of start of farming (year of start of farming/person).

Perception aspects of livestock cultivation which include seeds (cows, goats, and pigs), maintenance, slaughter, health and reproduction, business capital loans, availability of oil palm habitat as pasture, availability of feed from oil palm land, and aspects of community support, especially customary land rights owners and the surrounding community.

### 2.5. Data Analysis

Data analysis was used using descriptive statistics by calculating frequency, proportion, average, standard deviation values and presented in tabulated form. In the analysis of variance for principal components analysis (PCA) (Far & Yakhler, 2015; Hosseini et al. 2016), the goal of the analysis is to understand how much variation in the data is explained by each principal component. Principal components are linear combinations of the original variables, and each principal component has a weight (coefficient) associated with it. These weights indicate the relative contribution of each original variable to the principal components.

Values close to 1 or  $-1$  indicate a strong correlation between two variables, while values close to 0 indicate a weak correlation or no correlation. Correlation does not necessarily indicate a cause-and-effect relationship but only shows a linear relationship between variables. By using PCC, socio-cultural analysis of livestock farmers can provide insight into the relationship between relevant variables in the livestock context and help make better decisions in the sustainable socio-cultural development of livestock farming.

## 3. Results

### 3.1. Sociocultural Aspects of Breeders

The socio-cultural parameters of farmers in Warpramasi are discussed which include age, gender, farmer objectives of breeding livestock, experience, and number of livestock reared (cattle, pigs, goats, ducks, free-range chickens), and types of farmers' works (state officers, army/police, farmers, breeders, and private), as well as the year he started breeding. We consider these properties as indicators of socio-culture that have a strong relationship with farmers' productivities, and livestock productivities (Table 2).

**Table 2.** Socio-cultural characteristics of breeders in Warpramasi.

Parameter Socio-culture	Frequency	Proportion	Mean	StDv	Minimum	Maximum
<b>Age (yr)</b>			44.75	44.75	25	65
<b>Gender</b>						
<i>Man</i>	106	90.60	0.897	0.305	0.000	1.000
<i>Women</i>	12	10.26	0.103	0.305	0.000	1.000
<b>Objectives of livestock raising</b>						
<i>Business</i>	24	20.51	0,205	0,406	0.000	1.000
<i>Social</i>	88	75.21	0.744	0,439	0.000	1.000
<i>Culture</i>	3	2.56	0.026	0,159	0.000	1.000
<b>Experience (yr)</b>			7.419	4,522	0.000	21.000
<b>Livestock number (head):</b>						
<b>Cattle</b>						
<i>Calve</i>			2.675	1,686	0.000	10.000
<i>Grower</i>			2.521	2,128	0.000	12.000
<i>Adult</i>			4.043	2,276	0.000	12.000
<b>Pig</b>						
<i>Piglet</i>			0.265	0,950	0.000	5.000
<i>Gilt</i>			0.214	0,808	0.000	5.000
<i>Hog</i>			0.154	0,582	0.000	3.000
<b>Goat</b>						
<i>Kid</i>			0.111	0,389	0.000	2.000
<i>Yearling</i>			0.060	0,400	0.000	4.000
<i>Buck</i>			0.205	0,737	0.000	4.000
<b>Duck</b>						
<i>Duckling</i>			0.650	2,802	0.000	20.000
<i>Grower</i>			0.487	2,156	0.000	11.000
<i>Adults</i>			0.427	1,945	0.000	14.000
<b>Chicken</b>						
<i>Chick</i>			6.932	10,022	0.000	40.000
<i>Grower</i>			3.538	5,169	0.000	20.000
<i>Hen/Rooster</i>			2.735	4,016	0.000	20.000
<b>Jobs</b>						
<i>State officers</i>	3	2.56	0.026	0.206	0.000	2.000
<i>Army/Police</i>	1	0.85	0.009	0.092	0.000	1.000
<i>Farmer</i>	69	58.97	0.581	0.495	0.000	1.000
<i>Livestock farmer</i>	8	6.84	0.068	0.253	0.000	1.000
<i>Private</i>	23	19.66	0.197	0.399	0.000	1.000
<b>Experience (yr)</b>			2015	4.5	2001	2022

Information: 1. Age, 2. Gender (Male), 3. Gender (Female), 4. Purpose of raising: Business, 5. Purpose of raising: Social, 6. Purpose of raising customs/culture, 7. Experience, 8. Number of livestock Cows: Calve, 9. Number of Cows: Grower, 10. Number of Cows: Steer/Heifer, 11. Number of pigs: Piglet, 12. Number of pigs: Grower, 13. Number of pigs: Boar/Sows, 14. Number of goats: Kid, 15. Number of goats: Yearling/Grower, 16. Number of goats: Buck, 17. Number of ducks: Duckling, 18. Number of ducks: grower, 19. Number of ducks: adults, 20. Number of free-range chickens: Chick, 21. Number of village chickens: Grower, 22. Number of village chickens: Hen/Rooster, 23. Occupation: Civil servant, 24. Employment: Army/Police, 25. Employment: Farmer, 26. Employment: Breeder, 27. Employment: Private, 28. Years of Breeding

Discussion of socio-cultural aspects which include age, gender, breeder goals, experience, number of livestock, type of breeder's work, and year of start of farming can provide a more complete understanding of the social and cultural context of farmers. The average age of breeders in the study location was  $44.75 \pm 44.75$  years. Age can influence the farmer's approach and knowledge in raising livestock. Younger breeders may have a more innovative approach and tend to use modern technology in their livestock business, while older breeders may rely on traditional knowledge and inherited experience.

Gender roles in animal husbandry are also important to consider (Patel et al., 2016; Suradis-astra & Lubis, 2000). The gender ratio was found to be 106:12. Where the number of male breeders is more dominant (90.60%) compared to female breeders which is only 10.26%. Some cultures may have a different division of labor between men and women in raising livestock. For example, in some societies, men may be more likely to be involved in raising large animals such as cows or pigs, while women may be more involved in raising small animals such as goats or chickens.

The goals of breeders can also vary (Aritonang et al., 2018; Dady et al., 2018; Iyai et al., 2013). The goal of raising livestock is predominantly directed towards social needs (75.21%), followed by business goals (20.51%) and customs/culture (2.56%). Some ranchers may raise livestock as their primary livelihood, while others may do it as a side business or to provide for their family. The goals of the farm can influence the scale of production, the techniques used, and the business approach taken by the breeder.

The level of experience in raising livestock can also influence the success of breeders (Bell et al., 2018; Le Thi Minh et al., 2017; Quisumbing, 1996). Breeding experience was found to be  $7,419 \pm 4,522$  years. Farmers who have extensive experience may have more in-depth knowledge of animal management, health care, and best practices in the livestock industry.

The number of livestock kept by a farmer can have an impact on the scale of production and livestock management approaches. The largest number of livestock kept by farmers is chickens,  $6,932 \pm 10,022$  chickens/breeder for chicks, followed by chickens in the grower phase ( $3,538 \pm 5,169$  chickens), and broodstock  $1,735 \pm 4,016$  chickens/breeder. This is followed by mother cows, juvenile cows, and calves. Pigs, goats, and ducks are still kept in limited numbers. Farmers with larger herds may use more advanced technology and infrastructure, while farmers with smaller herds may use a more traditional approach and rely on manual labor.

The breeder's type of occupation can provide insight into their social and economic background. The type of work for breeders in Warpramasi is dominated by farmers (58.97%), followed by the private sector (19.66%), livestock breeders (6.84%), civil servants (2.56%) and the lowest is working as the Indonesian army force/police (TNI/Polri) (0.85%). Farmers who work as civil servants (PNS), army/police, farmers, livestock breeders, or private employees may have differences in resources, access to technology, or approaches to managing their farms.

The year of start of farming is also important to know because it can reflect changes in farming practices over time. On average, it was found that livestock cultivation businesses in Warpramasi Manokwari have been carried out since 2015. This can be confirmed that the breeders in Warpramasi have now been engaged by the younger generation as young breeders (millennial breeders). Farmers who have been farming for a long time may have adopted new innovations and existing technologies, while new breeders may still be learning best practices and developing their skills. Understanding these socio-cultural aspects will help in designing appropriate livestock development programs, understanding the challenges faced by livestock farmers, and promoting sustainable and inclusive practices in the livestock industry.

In general, determining the number of main components can be done using three approaches, namely the cumulative proportion of variance that can be explained by the main components. The main component taken is the main component that covers at least 80% of the variance in the data or can be said to be at least capable of capturing 80% of the diversity of the data (Figure 2).

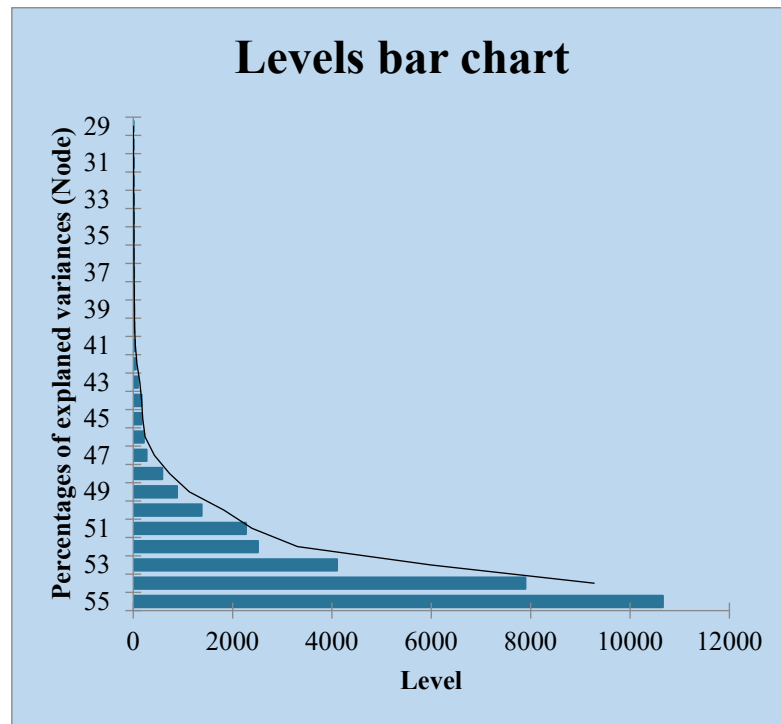

**Figure 2.** Profile of diversity (variance) explained by levels (dimensions).

Figure 2 explains the suitability of numbers for dimensions stored for creating clusters in Agglomerative Hierarchical Clustering (AHC) analysis using XLStat software. The second approach is Eigen Value. The main components taken are principal components that have an eigenvalue of more than one. The eigenvalues are obtained from the variance matrix or correlation matrix. Eigenvalues describe the variance explained by the principal components. The third approach is *Scree Plot* is a plot between the  $k$ th principal component and the variance or eigenvalue of that component (Figure 2).



**Table 3.** Analysis of various parameters used in socio-cultural aspects.

Variable	DF (Model)	Mean Squares (Model)	DF (Error)	Mean Squares (Error)	F	Pr > F
Age	2	230,384	115	67,136	3,432	<b>0,036</b>
Gender (Male)	2	0,107	115	0,092	1,168	0,315
Gender (Female)	2	0,107	115	0,092	1,168	0,315
Purpose of raising: Business	2	0,302	115	0,161	1,874	0,158
Purpose of raising: Social	2	0,262	115	0,190	1,381	0,255
Purpose of raising: Custom/Culture	2	0,017	115	0,025	0,670	0,514
Experience (yr)	2	324,738	115	15,040	21,592	<b>&lt;0,0001</b>
Sum of cattle: Calve	2	3,794	115	2,805	1,353	0,263
Sum of cattle: Grower	2	8,554	115	4,437	1,928	0,150
Sum of Cattle: Steer/Heifer	2	11,179	115	5,038	2,219	0,113
Sum of pig: Piglet	2	1,479	115	0,886	1,669	0,193
Sum of pig: Grower	2	0,590	115	0,648	0,911	0,405
Sum of pig: Boar/Sow	2	0,389	115	0,335	1,162	0,317
Sum of goat: Kid	2	0,052	115	0,152	0,343	0,710
Sum of goat: yearling/grower	2	0,119	115	0,160	0,748	0,475
Sum of goat: Buck	2	0,178	115	0,546	0,326	0,722
Sum of duck: Duckling	2	2,258	115	7,883	0,286	0,751
Sum of duck: grower	2	1,882	115	4,658	0,404	0,669
Sum of duck: Adult	2	1,235	115	3,794	0,325	0,723
Sum of chicken: Chick	2	3847,594	115	34,817	110,510	<b>&lt;0,0001</b>
Sum of chicken: Grower	2	1002,793	115	9,617	104,278	<b>&lt;0,0001</b>
Sum of chicken: Hen/Rooster	2	620,462	115	5,542	111,965	<b>&lt;0,0001</b>
Occupation: Civil servant	2	0,072	115	0,042	1,732	0,182
Occupation: Army/Police	2	0,058	115	0,008	7,657	<b>0,001</b>
Occupation: Farmer	2	2,027	115	0,214	9,478	<b>0,000</b>
Occupation: Livestock farmer	2	0,037	115	0,064	0,575	0,564
Occupation: Private	2	0,583	115	0,151	3,861	<b>0,024</b>
Year of breeding	2	269,552	115	15,886	16,968	<b>&lt;0,0001</b>

In PCA (Principal Component Analysis), contribution represents how much information or variation each principal component provides to the original dataset. The principal component contribution describes the proportion of total variation in the dataset that can be explained by each component. In the context of analysis of variance in PCA, contribution refers to how much variation in the dataset is explained by each principal component. Analysis of variance is used to check how significant each principal component is in influencing the variation in the dataset. The principal component contribution is calculated by squaring the eigenvalues associated with each principal component and then dividing by the total number of eigenvalues. In PCA, eigenvalues indicate how much variation is explained by each principal component. By squaring the eigenvalues, the percentage of contribution or variation explained by each main component can be calculated.

A higher contribution indicates that the principal component has a greater influence on the variation in the dataset. Therefore, principal components with high contributions are usually retained, while components with low contributions can be ignored or deleted because they contribute little to the total variation in the dataset. The results of the analysis show that the variables are age ( $p < 0.05$ ), experience ( $p < 0.01$ ), number of free-range chickens ( $p < 0.01$ ), occupation, namely Army/Police ( $p < 0.01$ ), Farmer ( $p < 0.01$ ), Private ( $p < 0.05$ ) and Year of farming ( $p < 0.01$ ) had a greater influence on variation in the dataset (Table 3).

By analyzing the contribution of each principal component, PCA helps in selecting the most important parameters and reduces the dimensionality of the dataset. It is possible to understand the basic structure of the data better and identify significant patterns or relationships.

**Table 4.** Factor analysis of combined data (FAMD).

Variable	Component				
	F1	F2	F3	F4	F5
Age	-0,467	0,332	0,232	-0,126	0,058
Gender (Male)	0,176	-0,120	0,045	-0,336	0,113
Gender (Female)	-0,176	0,120	-0,045	0,336	-0,113
Purpose of raising: Business	-0,015	-0,277	<b>0,630</b>	0,017	-0,183
Purpose of raising: Social	-0,069	0,271	<b>-0,646</b>	-0,010	0,178
Purpose of raising: Custom/Culture	0,084	0,051	0,016	0,037	-0,085
Experience (yr)	<b>-0,666</b>	0,319	0,064	-0,410	0,271
Sum of cattle: Calve	<b>-0,589</b>	0,025	0,236	0,000	0,421
Sum of cattle: Grower	<b>-0,567</b>	0,027	0,353	0,132	0,402
Sum of Cattle: Steer/Heifer	<b>-0,533</b>	0,111	<b>0,535</b>	0,105	0,358
Sum of pig: Piglet	-0,451	<b>-0,591</b>	-0,201	<b>0,578</b>	0,051
Sum of pig: Grower	-0,416	<b>-0,529</b>	-0,220	<b>0,622</b>	0,067
Sum of pig: Boar/Sow	-0,409	<b>-0,576</b>	-0,174	<b>0,556</b>	0,043
Sum of goat: Kid	0,256	-0,012	0,641	0,251	-0,306
Sum of goat: yearling/grower	-0,026	0,188	<b>0,614</b>	0,288	0,030
Sum of goat: Buck	0,243	-0,044	<b>0,735</b>	0,242	-0,215
Sum of duck: Duckling	0,451	-0,266	0,081	-0,067	0,655
Sum of duck: grower	<b>0,502</b>	-0,340	0,120	-0,089	<b>0,629</b>
Sum of duck: Adult	0,479	-0,234	0,019	-0,036	<b>0,666</b>
Sum of chicken: Chick	0,103	<b>0,591</b>	0,001	0,414	0,344
Sum of chicken: Grower	0,201	<b>0,515</b>	-0,211	<b>0,530</b>	0,295
Sum of chicken: Hen/Rooster	0,250	<b>0,545</b>	-0,156	<b>0,543</b>	0,192
Occupation: Civil servant	-0,001	0,070	0,016	-0,036	-0,013
Occupation: Army/Police	-0,029	0,110	-0,051	-0,032	0,044
Occupation: Farmer	0,223	<b>0,535</b>	-0,020	0,339	-0,133
Occupation: Livestock farmer	0,463	-0,326	0,132	-0,057	0,371
Occupation: Private	-0,343	-0,408	-0,220	-0,142	-0,100
Year of breeding	<b>0,747</b>	-0,262	-0,019	0,341	-0,263
Eigenvalue	4,100	3,203	2,948	2,693	2,539
Variability (%)	14,642	11,439	10,530	9,618	9,070
Cumulative %	14,642	26,081	36,611	46,228	<b>55,298</b>

The number of correlation values ( $r > 0.5$ ) is greater in the factors in Table 4. The variables used are 28 and 5 main components are used based on Figure 2. on the scree plot graph. Table 4 cumulative value (%) explains 55.298% of the total variation value.

**Table 5.** Correlation matrix.

From/to	1	2	3	4	5	6	7	8	9	10	11	12	13	14	15	16	17	18	19	20	21	22	23	24	25	26	27	28
1	1	0,011	-0,01	-0,00	0,046	-0,12	0,507	0,231	0,229	0,281	-0,04	-0,03	-0,02	0,042	0,194	0,078	-0,17	-0,17	-0,19	0,111	-0,00	-0,07	0,088	-0,05	0,073	-0,29	0,004	-0,48
2	0,011	1	-1,00	-0,03	-0,00	0,054	-0,04	-0,06	-0,00	-0,04	-0,11	-0,12	-0,00	-0,04	0,050	0,017	0,078	0,076	0,074	-0,04	-0,02	-0,09	0,042	0,031	-0,11	0,091	0,024	0,126
3	-0,01	-1,00	1	0,039	0,003	-0,05	0,048	0,066	0,008	0,042	0,114	0,121	0,008	0,049	-0,05	-0,01	-0,07	-0,07	-0,07	0,049	0,027	0,095	-0,04	-0,03	0,113	-0,09	-0,02	-0,12
4	-0,00	-0,03	0,039	1	-0,86	-0,08	-0,05	0,138	0,022	0,184	0,016	-0,02	0,085	0,183	0,190	0,291	-0,04	-0,00	-0,06	-0,11	-0,23	-0,11	0,040	-0,04	-0,13	0,199	-0,03	0,070
5	0,046	-0,00	0,003	-0,86	1	-0,27	0,083	-0,10	0,000	-0,14	0,018	0,057	-0,04	-0,23	-0,20	-0,29	-0,01	-0,05	0,048	0,118	0,206	0,129	-0,02	0,054	0,100	-0,23	0,091	-0,10
6	-0,12	0,054	-0,05	-0,08	-0,27	1	-0,08	0,000	-0,01	0,020	-0,04	-0,04	-0,04	-0,04	-0,02	-0,04	-0,03	-0,03	-0,03	-0,00	0,089	0,012	-0,02	-0,01	0,136	-0,04	-0,07	0,090
7	0,507	-0,04	0,048	-0,05	0,083	-0,08	1	0,378	0,383	0,356	-0,08	-0,12	-0,08	-0,23	-0,02	-0,23	-0,14	-0,19	-0,17	0,087	-0,11	-0,14	-0,02	0,094	-0,15	-0,22	0,118	-0,94
8	0,231	-0,06	0,066	0,138	-0,10	0,000	0,378	1	0,539	0,666	0,200	0,179	0,131	-0,19	0,030	-0,16	-0,01	-0,05	-0,05	0,037	-0,05	-0,04	0,074	0,018	-0,13	-0,08	-0,01	-0,45
9	0,229	-0,00	0,008	0,022	0,000	-0,01	0,383	0,539	1	0,649	0,223	0,218	0,211	0,021	0,316	0,089	-0,01	-0,04	-0,06	0,096	0,025	-0,07	-0,07	-0,02	-0,12	-0,10	0,078	-0,40
10	0,281	-0,04	0,042	0,184	-0,14	0,020	0,356	0,666	0,649	1	0,125	0,121	0,092	0,062	0,384	0,199	-0,02	-0,08	-0,04	0,104	-0,00	-0,07	0,016	0,039	-0,07	-0,12	-0,08	-0,39
11	-0,04	-0,11	0,114	0,016	0,018	-0,04	-0,08	0,200	0,223	0,125	1	0,936	0,908	-0,08	-0,04	-0,07	-0,06	-0,06	-0,06	-0,12	-0,05	-0,09	-0,03	-0,02	-0,16	-0,07	0,294	-0,01
12	-0,03	-0,12	0,121	-0,02	0,057	-0,04	-0,12	0,179	0,218	0,121	0,936	1	0,866	-0,07	-0,04	-0,07	-0,06	-0,06	-0,05	-0,08	0,025	-0,04	-0,03	-0,02	-0,09	-0,07	0,217	0,002
13	-0,02	-0,00	0,008	0,085	-0,04	-0,04	-0,08	0,131	0,211	0,092	0,908	0,866	1	-0,07	-0,04	-0,07	-0,06	-0,06	-0,05	-0,10	-0,00	-0,06	-0,03	-0,02	-0,13	-0,07	0,278	-0,01
14	0,042	-0,04	0,049	0,183	-0,23	-0,04	-0,23	-0,19	0,021	0,062	-0,08	-0,07	-0,07	1	0,400	0,882	0,013	0,048	-0,01	-0,00	-0,10	-0,02	-0,03	-0,02	0,151	0,010	-0,14	0,280
15	0,194	0,050	-0,05	0,190	-0,20	-0,02	-0,02	0,030	0,316	0,384	-0,04	-0,04	-0,04	0,400	1	0,455	-0,03	-0,03	-0,03	0,261	0,114	0,134	-0,01	-0,01	0,083	-0,04	-0,07	0,053
16	0,078	0,017	-0,01	0,291	-0,29	-0,04	-0,23	-0,16	0,089	0,199	-0,07	-0,07	-0,07	0,882	0,455	1	0,061	0,116	0,011	0,001	-0,06	-0,02	-0,03	-0,02	0,070	0,063	-0,13	0,271
17	-0,17	0,078	-0,07	-0,04	-0,01	-0,03	-0,14	-0,01	-0,01	-0,02	-0,06	-0,06	-0,06	0,013	-0,03	0,061	1	0,704	0,721	0,012	0,048	-0,00	-0,02	-0,02	-0,06	0,447	-0,11	0,164
18	-0,17	0,076	-0,07	-0,00	-0,05	-0,03	-0,19	-0,05	-0,04	-0,08	-0,06	-0,06	-0,06	0,048	-0,03	0,116	0,704	1	0,809	0,023	-0,06	-0,06	-0,02	-0,02	-0,10	0,522	-0,11	0,219
19	-0,19	0,074	-0,07	-0,06	0,048	-0,03	-0,17	-0,05	-0,06	-0,04	-0,06	-0,05	-0,05	-0,01	-0,03	0,011	0,721	0,809	1	0,095	0,062	0,016	-0,02	-0,02	-0,01	0,325	-0,10	0,198
20	0,111	-0,04	0,049	-0,11	0,118	-0,00	0,087	0,037	0,096	0,104	-0,12	-0,08	-0,10	-0,00	0,261	0,001	0,012	0,023	0,095	1	0,632	0,676	0,106	-0,00	0,300	-0,01	-0,18	-0,03
21	-0,00	-0,02	0,027	-0,23	0,206	0,089	-0,11	-0,05	0,025	-0,00	-0,05	0,025	-0,00	-0,10	0,114	-0,06	0,048	-0,06	0,062	0,632	1	0,791	0,028	0,081	0,291	0,085	-0,22	0,139
22	-0,07	-0,09	0,095	-0,11	0,129	0,012	-0,14	-0,04	-0,07	-0,07	-0,09	-0,04	-0,06	-0,02	0,134	-0,02	-0,00	-0,06	0,016	0,676	0,791	1	-0,06	0,030	0,336	0,045	-0,23	0,167
23	0,088	0,042	-0,04	0,040	-0,02	-0,02	-0,02	0,074	-0,07	0,016	-0,03	-0,03	-0,03	-0,03	-0,01	-0,03	-0,02	-0,02	-0,02	0,106	0,028	-0,06	1	-0,01	0,021	-0,03	-0,06	0,032
24	-0,05	0,031	-0,03	-0,04	0,054	-0,01	0,094	0,018	-0,02	0,039	-0,02	-0,02	-0,02	-0,02	-0,01	-0,02	-0,02	-0,02	-0,02	-0,00	0,081	0,030	-0,01	1	0,078	-0,02	-0,04	-0,10
25	0,073	-0,11	0,113	-0,13	0,100	0,136	-0,15	-0,13	-0,12	-0,07	-0,16	-0,09	-0,13	0,151	0,083	0,070	-0,06	-0,10	-0,01	0,300	0,291	0,336	0,021	0,078	1	-0,32	-0,58	0,135
26	-0,29	0,091	-0,09	0,199	-0,23	-0,04	-0,22	-0,08	-0,10	-0,12	-0,07	-0,07	-0,07	0,010	-0,04	0,063	0,447	0,522	0,325	-0,01	0,085	0,045	-0,03	-0,02	-0,32	1	-0,13	0,266
27	0,004	0,024	-0,02	-0,03	0,091	-0,07	0,118	-0,01	0,078	-0,08	0,294	0,217	0,278	-0,14	-0,07	-0,13	-0,11	-0,11	-0,10	-0,18	-0,22	-0,23	-0,06	-0,04	-0,58	-0,13	1	-0,15
28	-0,48	0,126	-0,12	0,070	-0,10	0,090	-0,94	-0,45	-0,40	-0,39	-0,01	0,002	-0,01	0,280	0,053	0,271	0,164	0,219	0,198	-0,03	0,139	0,167	0,032	-0,10	0,135	0,266	-0,15	1

Information: 1. Age, 2. Gender (Male), 3. Gender (Female), 4. Purpose of raising: Business, 5. Purpose of raising: Social, 6. Purpose of raising customs/culture, 7. Experience, 8. Number of livestock Cows: Calve, 9. Number of Cows: Grower, 10. Number of Cows: Steer/Heifer, 11. Number of pigs: Piglet, 12. Number of pigs: Grower, 13. Number of pigs: Boar/Sows, 14. Number of goats: Kid, 15. Number of goats: Yearling/Grower, 16. Number of goats: Buck, 17. Number of ducks: Duckling, 18. Number of ducks: grower, 19. Number of ducks: adults, 20. Number of freerange chickens: Chick, 21. Number of village chickens: Grower, 22. Number of village chickens: Hen/Rooster, 23. Occupation: Civil servant, 24. Employment: Army/Police, 25. Employment: Farmer, 26. Employment: Breeder, 27. Employment: Private, 28. Years of Breeding.

The Pearson Coefficient Correlation (PCC) matrix (Table 5), can be used in the socio-cultural analysis of breeders to determine the relationship or interrelationship between two or more variables contained in the breeders' socio-cultural data. The PCC matrix is a statistical measure that measures the degree to which two variables move together or are linearly related. This coefficient can range between  $-1$  to  $+1$ , with a value of  $+1$  indicating perfect positive correlation, a value of  $-1$  indicating perfect negative correlation, and a value of  $0$  indicating no linear correlation between two variables.

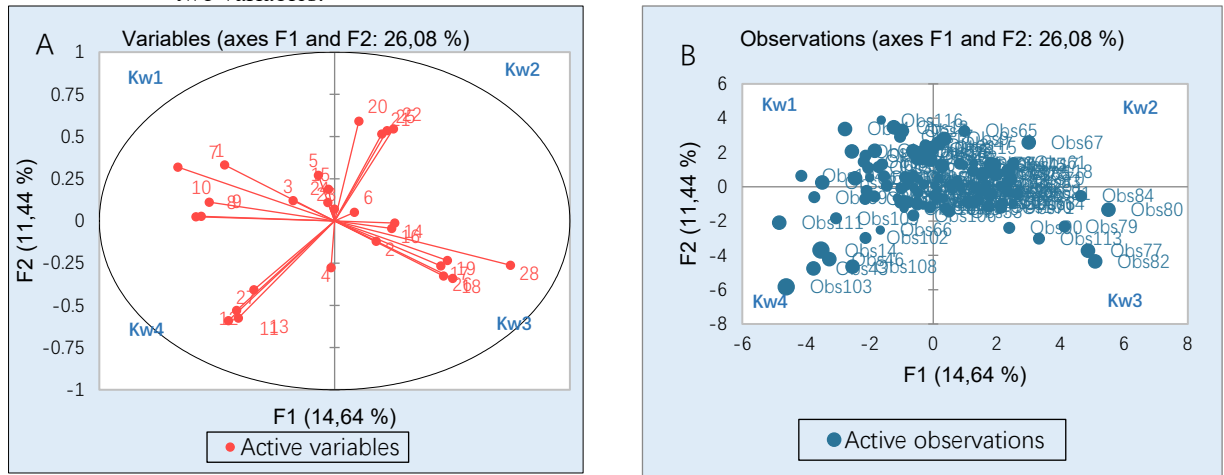

A. Biplot graph of distribution and relationship between variables inside quadrant: Kw1–Kw4.

B. Distribution of farmers inside Biplot graph.

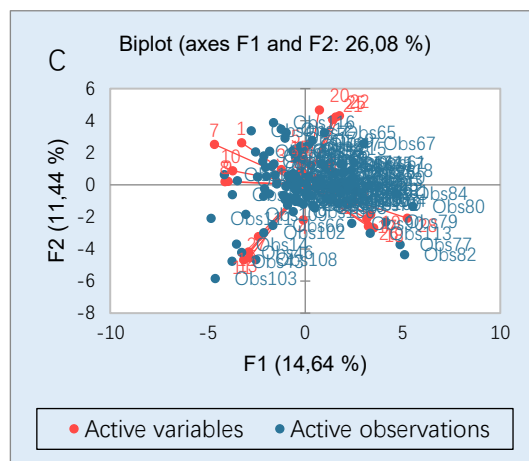

C. Variable and farmers mapping inside Biplot graph.

**Figure 3.** Description of Biplot graph concerning properties of socio-culture (A, B, and C).

**Information:** 1. Age, 2. Gender (Male), 3. Gender (Female), 4. Purpose of raising: Business, 5. Purpose of raising: Social, 6. Purpose of raising customs/culture, 7. Experience, 8. Number of livestock Cows: Calve, 9. Number of Cows: Grower, 10. Number of Cows: Steer/Heifer, 11. Number of pigs: Piglet, 12. Number of pigs: Grower, 13. Number of pigs: Boar/Sows, 14. Number of goats: Kid, 15. Number of goats: Yearling/Grower, 16. Number of goats: Buck, 17. Number of ducks: Duckling, 18. Number of ducks: grower, 19. Number of ducks: adults, 20. Number of free-range chickens: Chick, 21. Number of village chickens: Grower, 22. Number of village chickens: Hen/Rooster, 23. Occupation: Civil servant, 24. Employment: Army/Police, 25. Employment: Farmer, 26. Employment: Breeder, 27. Employment: Private, 28. Years of Breeding

In the context of socio-cultural analysis of breeders, PCC can help in understanding the relationship between variables that are relevant to the socio-cultural aspects of breeders. Examples of variables that can be correlated include age with farming experience, farming experience with the number of livestock owned by the farmer. The PCC matrix can be used to evaluate whether there is a correlation between livestock farmers' access to agricultural technology, such as modern equip-

ment or irrigation systems, and livestock production levels. This can help identify factors that contribute to increased production and can also help in understanding the socio-cultural impact on livestock sustainability.

Quadrant I (Kw1) is negatively correlated with the F1 axis and positive with the F2 axis (Figure 3A). Quadrant II (Kw2) is positively correlated with the F1 and F2 axes. Quadrant III (Kw3) is positively correlated with the F1 axis and negative with the F2 axis. Meanwhile, Quadrant IV (Kw4) is negatively correlated with F1 and F2. In Qw1 the variables contained there are age, female gender, social goals for raising livestock, experience, number of calf cattle, number of juvenile cattle, number of cow cattle, number of kid goats, type of civil servant work, and type of army/police work. In Kw2 the variables grouped are the purpose of raising livestock for custom/culture, the number of free-range chickens (day old chicks), the number of local chickens (parental stocks), and the type of work of farmers. Farmers are concentrated in Quadrant 2 (Kw2) and Quadrant 3 (Kw3) (Figure 3B). Meanwhile, the variables for Kw3 are male gender, number of goats (children), number of goats (parents), number of ducks, number of ducks (adolescents), number of ducks (parents), breeder's type of work, and year of farming (Figure 3C). Finally, for Kw4 there are variables such as the purpose of raising (business), number of pigs (piglets), number of pigs (growers), and number of pigs (parents).

### 3.2. Perceptual Aspects of Animal Cultivation

Perception aspects of livestock cultivation which include seeds (cows, goats and pigs), maintenance, slaughter, health and reproduction, business capital loans, availability of oil palm habitat as grazing land, availability of feed from oil palm land and aspects of community support, especially customary land rights owners and the surrounding community are central in the following discussion (Table 6).

**Table 6.** Farmers' perceptions regarding the cultivation of cattle, goats, and pigs in Warpramasi.

Parameter of Perception		Frequency	Proportion	Mean	Std. deviation	Minimum	Maximum
1. Breed	Cattle	315	266,9	2,675	0,859	0,000	4,000
2. Breed	Goat	31	26,27	0,265	0,904	0,000	4,000
3. Breed	Pig	9	7,627	0,077	0,494	0,000	4,000
4. Rearing	Cattle	307	260,2	2,607	0,820	0,000	4,000
5. Rearing	Goat	35	29,66	0,299	1,002	0,000	4,000
6. Rearing	Pig	6	5,085	0,051	0,412	0,000	4,000
7. Cutting	Cattle	315	266,9	2,675	0,829	0,000	4,000
8. Cutting	Goat	31	26,27	0,274	0,925	0,000	4,000
9. Cutting	Pig	11	9,322	0,094	0,587	0,000	4,000
10. Veterinary/Reproduction	Cattle	311	263,6	2,641	0,701	2,000	4,000
11. Veterinary/Reproduction	Goat	29	24,58	0,248	0,829	0,000	4,000
12. Veterinary/Reproduction	Pig	7	5,932	0,060	0,460	0,000	4,000
13. Capital loan	Cattle	163	138,1	1,393	1,645	0,000	4,000
14. Capital loan	Goat	30	25,42	0,256	0,873	0,000	4,000
15. Capital loan	Pig	7	5,932	0,060	0,460	0,000	4,000
16. Palm oil land availability	Cattle	293	248,3	2,487	0,934	0,000	4,000
17. Palm oil land availability	Goat	28	23,73	0,239	0,847	0,000	4,000
18. Palm oil land availability	Pig	7	5,932	0,060	0,378	0,000	3,000
19. Forages from crops	Cattle	242	205,1	2,068	1,413	0,000	4,000
20. Forages from crops	Goat	26	22,03	0,222	0,842	0,000	4,000
21. Forages from crops	Pig	14	11,86	0,120	0,590	0,000	4,000
22. Local community support	Cattle	305	258,5	2,590	0,767	1,000	4,000
23. Local community support	Goat	30	25,42	0,256	0,882	0,000	4,000
24. Local community support	Pig	7	5,932	0,060	0,378	0,000	3,000

The perception aspect of livestock cultivation includes several important things that need to be considered. The following is a discussion of these aspects in the context of raising cattle, goats, and pigs, as well as related factors. Choosing quality livestock seeds is very important to start successful cultivation. For the evaluation of the perception of cattle breeders in Warpramasi, the score was  $2.675 \pm 0.859$ , which is good. Meanwhile, goat and pig breeders scored  $0.265 \pm 0.904$  and  $0.077 \pm 0.494$ . In the context of cattle, goats and pigs, good seeds are animals that are healthy, have

superior genetics, and come from a trusted source. A good perception of these seeds includes understanding the importance of choosing superior seeds and maintaining the cleanliness and health of livestock seeds.

This maintenance aspect includes aspects of the environment, feed, water, cleanliness, and cage management. The perception of cattle breeders is at  $2.607 \pm 0.820$ , followed by goat and pig breeders. Having a good perception of husbandry means understanding the importance of providing a healthy environment, meeting adequate feed and water requirements, keeping the pen clean, and implementing good management in managing livestock. The aspect of slaughtering livestock is part of the process of utilizing livestock products. The best score was given by cattle breeders, namely  $2.675 \pm 0.829$  and continued by goat and pig breeders. In this context, good perception involves understanding the importance of slaughtering animals using the correct procedures, maintaining cleanliness, and ensuring slaughter is carried out humanely and follows animal welfare principles.

Good perception of health and reproductive aspects includes understanding the importance of vaccination, disease prevention, routine health care, and good reproductive management. From this indicator, it can be said that the average perception of cattle farming has a better perception, namely  $2.641 \pm 0.701$ , followed by goat breeders and pig breeders. Livestock owners must understand the importance of maintaining livestock health so that productivity remains optimal and ensures healthy and controlled reproduction.

In livestock cultivation, business capital is sometimes needed to start or develop a livestock business. The perception value of cattle breeders dominates, namely  $1.393 \pm 1.645$ , followed by goat breeders and pig breeders. A good perception of business capital loans involves understanding the terms and conditions of the loan, the risks involved, and the ability to manage and repay the loan in a timely manner. In the context of raising cattle and goats, oil palm can be used as pasture. In real terms, it can be said that this aspect is still dominated by cattle breeders, namely  $2.487 \pm 0.934$  and followed by goat breeders and pig breeders. Good perception involves understanding the potential and limitations of using oil palm as pasture, including sustainability, environmental management, and good management to ensure the sustainability of animal feed sources.

Good perception includes an understanding of the use of oil palm land as a source of animal feed, including available nutrients, the sustainability of the feed source, as well as its potential impact on the environment and animal feed quality. The availability of oil palm habitat was shown with a perception value of  $2.068 \pm 1.413$  and was followed further by goat breeders and pig breeders. A good perception of community support includes building harmonious relationships with customary rights owners and surrounding communities. This indicator value was achieved by cattle breeders with a score of  $2.590 \pm 0.767$  followed by goat breeders and pig breeders. This involves good communication, understanding community needs and interests, and involvement in local social and economic activities. It is important to note that these aspects are general things that need to be considered in livestock farming. However, each context and location can have differences in perception and implementation.

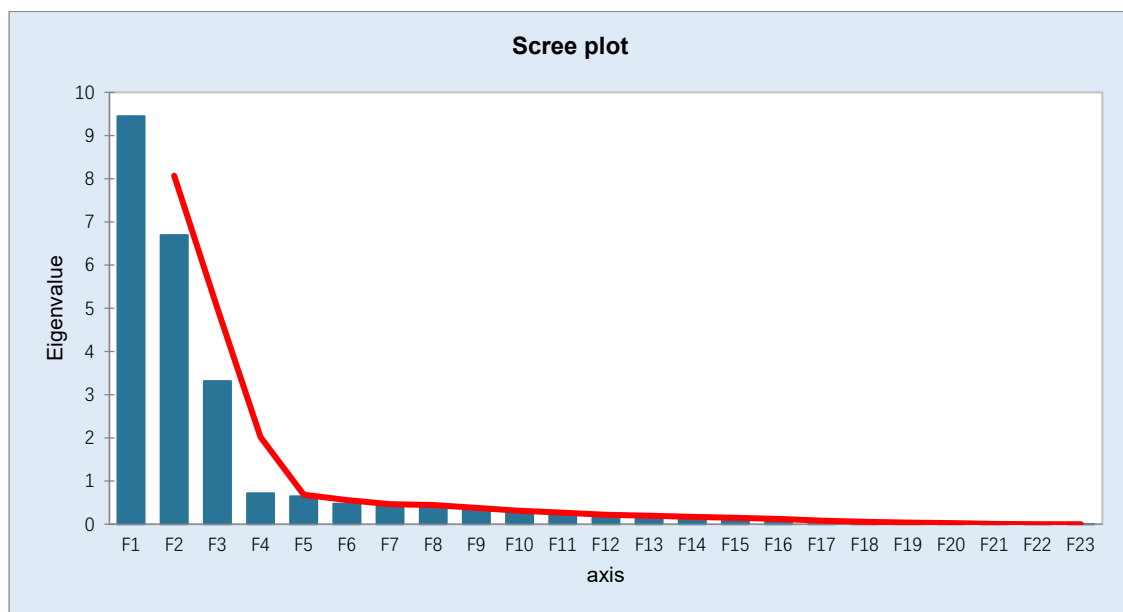

**Figure 4.** Scree plot values.

Figure 4 explains the suitability of numbers for dimensions stored for creating clusters in Agglomerative Hierarchical Clustering (AHC) analysis using XLStat software. The scree plot diagram

basically has the same function as the total variance explained table, namely its function is to see the factors formed from the results of analysis based on eigenvalues. The way to read a scree plot diagram is to look at the eigenvalues (on the Y axis), which have eigenvalues > 1. If the eigenvalues are more than 1 then that is the factor that is formed. Based on the diagram above, it can be seen that there are 3 points that have eigenvalues >1, this means that there are 3 factors formed.

**Table 7.** Factor analysis of combined data (FAMD).

Variable		Components		
		F1	F2	F3
<b>Breed</b>	Cattle	<b>0,691</b>	0,118	0,462
	Goat	<b>0,836</b>	-0,345	-0,329
	Pig	0,232	<b>0,861</b>	-0,216
<b>Rearing</b>	Cattle	<b>0,62</b>	<b>0,185</b>	<b>0,555</b>
	Goat	<b>0,855</b>	-0,372	-0,324
	Pig	0,264	<b>0,89</b>	-0,199
<b>Cutting</b>	Cattle	<b>0,597</b>	0,074	<b>0,636</b>
	Goat	<b>0,846</b>	-0,345	-0,329
	Pig	0,252	<b>0,766</b>	-0,039
<b>Veterinary/Reproduction</b>	Cattle	<b>0,564</b>	0,238	<b>0,512</b>
	Goat	<b>0,856</b>	-0,361	-0,334
	Pig	0,273	<b>0,909</b>	-0,19
<b>Capital loan</b>	Cattle	<b>0,65</b>	0,046	<b>0,501</b>
	Goat	<b>0,844</b>	-0,36	-0,333
	Pig	0,275	<b>0,921</b>	-0,2
<b>Palm oil land availability</b>	Cattle	<b>0,603</b>	0,011	<b>0,508</b>
	Goat	<b>0,828</b>	-0,379	-0,298
	Pig	0,352	<b>0,8</b>	-0,238
<b>Forage from crops</b>	Cattle	<b>0,556</b>	0,091	<b>0,536</b>
	Goat	<b>0,771</b>	-0,359	-0,248
	Pig	0,491	<b>0,648</b>	-0,271
<b>Local community support</b>	Cattle	<b>0,704</b>	0,055	0,437
	Goat	<b>0,837</b>	-0,357	-0,293
	Pig	0,207	<b>0,826</b>	-0,251
	Eigenvalue	9,447	6,695	3,314
	Variability (%)	39,361	27,897	13,806
	Cumulative %	39,361	67,258	81,064

In Table 7, there are 24 variables used and 3 main components are used based on Figure 4 in the graph scree plot. Table 7. Cumulative value (%) explains 86.745% of the total variation value.

The results of the analysis show that the variable perception of livestock seeds owned by cattle and goat breeders is very significant ( $p < 0.01$ ) and varies in influence in the dataset. Likewise, aspects of maintenance perception had very significant variations in both cattle and goats ( $p < 0.01$ ) but had no significant influence in variations in pigs. This insignificant perception by farmers was caused by a number of cases of disease during the Covid-19 period and attacks by swine flu (ASF). The aspect of slaughtering cattle and goats experienced by breeders of these two commodities is also very significant ( $p < 0.01$ ) compared to pig breeders ( $p > 0.05$ ). The same is true in the aspect of livestock health and livestock reproduction, which is very significant for both cattle and goat breeders ( $p < 0.01$ ). Borrowing business capital from other partners was experienced favourably by both cattle and goat breeders ( $p < 0.01$ ), compared to pig breeders. The availability of livestock grazing habitat was experienced as very significant ( $p < 0.01$ ) by both cattle and goat breeders, but not by pig breeders.

**Table 8.** Analysis of diversity of parameters (variables) in aspects of farmer perception.

Variable		DF (Model)	Mean squares (Model)	DF (Er- ror)	Mean squares (Error)	F	Pr > F
<b>Breed</b>	Cattle	2	13,709	115	0,510	26,860	<0,0001
	Goat	2	43,978	115	0,060	732,966	<0,0001
	Pig	2	0,252	115	0,242	1,044	0,355
<b>Rearing</b>	Cattle	2	12,144	115	0,469	25,867	<0,0001
	Goat	2	56,059	115	0,039	1432,627	<0,0001
	Pig	2	0,112	115	0,169	0,662	0,518
<b>Cutting</b>	Cattle	2	12,459	115	0,480	25,961	<0,0001
	Goat	2	46,861	115	0,049	962,324	<0,0001
	Pig	2	0,048	115	0,347	0,137	0,872
<b>Veterinary/Reproduction</b>	Cattle	2	4,926	115	0,413	11,930	<0,0001
	Goat	2	38,486	115	0,025	1526,186	<0,0001
	Pig	2	0,153	115	0,211	0,723	0,487
<b>Capital loan</b>	Cattle	2	134,597	115	0,406	331,835	<0,0001
	Goat	2	41,186	115	0,052	789,407	<0,0001
	Pig	2	0,153	115	0,211	0,723	0,487
<b>Palm oil land availability</b>	Cattle	2	17,149	115	0,584	29,362	<0,0001
	Goat	2	35,878	115	0,101	355,687	<0,0001
	Pig	2	0,176	115	0,141	1,248	0,291
<b>Forage from crops</b>	Cattle	2	48,002	115	1,215	39,517	<0,0001
	Goat	2	30,936	115	0,177	174,392	<0,0001
	Pig	2	1,980	115	0,316	6,258	0,003
<b>Local community support</b>	Cattle	2	10,017	115	0,423	23,695	<0,0001
	Goat	2	41,186	115	0,070	592,055	<0,0001
	Pig	2	0,153	115	0,142	1,078	0,344

An aspect that also has very significant variation in the dataset is the aspect of feed availability from agricultural land for the three commodity breeders of cattle, goats, and pigs. The aspect of community support is an important variable when livestock farming experiences constraints from other communities. The data in the Table 8 shows that there is variability in data for cattle and goat farms ( $p < 0.01$ ) compared to pig breeders ( $p > 0.05$ ).

By analyzing the contribution of each principal component, PCA helps in selecting the most important parameters and reduces the dimensionality of the dataset. It is possible to understand the basic structure of the data better and identify significant patterns or relationships.



**Table 9.** Correlation matrix.

from \ to	1	2	3	4	5	6	7	8	9	10	11	12	13	14	15	16	17	18	19	20	21	22	23	24
1	1	0,368	0,162	0,736	0,405	0,194	0,676	0,396	0,249	0,595	0,393	0,202	0,648	0,389	0,202	0,512	0,393	0,194	0,561	0,363	0,282	0,739	0,384	0,141
2	0,368	1	-0,046	0,271	0,949	-0,036	0,244	0,944	-0,047	0,275	0,969	-0,038	0,365	0,952	-0,038	0,347	0,884	0,155	0,264	0,806	0,296	0,395	0,876	-0,046
3	0,162	-0,046	1	0,182	-0,046	0,828	0,104	-0,046	0,718	0,206	-0,047	0,927	0,091	-0,046	0,889	-0,025	-0,044	0,760	0,129	-0,041	0,708	0,107	-0,045	0,760
4	0,736	0,271	0,182	1	0,272	0,214	0,675	0,269	0,275	0,580	0,273	0,223	0,661	0,276	0,223	0,647	0,287	0,216	0,555	0,279	0,277	0,675	0,297	0,161
5	0,405	0,949	-0,046	0,272	1	-0,037	0,296	0,971	-0,048	0,205	0,988	-0,039	0,384	0,976	-0,039	0,341	0,930	0,089	0,279	0,850	0,231	0,431	0,926	-0,047
6	0,194	-0,036	0,828	0,214	-0,037	1	0,100	-0,037	0,693	0,244	-0,037	0,893	0,123	-0,037	0,984	0,069	-0,035	0,866	0,113	-0,033	0,684	0,177	-0,036	0,866
7	0,676	0,244	0,104	0,675	0,296	0,100	1	0,287	0,206	0,631	0,282	0,142	0,684	0,284	0,120	0,619	0,285	0,118	0,677	0,266	0,152	0,672	0,281	-0,046
8	0,396	0,944	-0,046	0,269	0,971	-0,037	0,287	1	-0,047	0,221	0,978	-0,038	0,383	0,981	-0,038	0,334	0,884	0,150	0,283	0,774	0,335	0,403	0,896	-0,047
9	0,249	-0,047	0,718	0,275	-0,048	0,693	0,206	-0,047	1	0,230	-0,048	0,777	0,123	-0,047	0,745	0,152	-0,045	0,635	0,190	-0,042	0,590	0,221	-0,047	0,635
10	0,595	0,275	0,206	0,580	0,205	0,244	0,631	0,221	0,230	1	0,230	0,254	0,538	0,196	0,254	0,639	0,205	0,310	0,552	0,225	0,356	0,624	0,249	0,180
11	0,393	0,969	-0,047	0,273	0,988	-0,037	0,282	0,978	-0,048	0,230	1	-0,039	0,384	0,983	-0,039	0,344	0,921	0,118	0,281	0,809	0,292	0,406	0,925	-0,047
12	0,202	-0,038	0,927	0,223	-0,039	0,893	0,142	-0,038	0,777	0,254	-0,039	1	0,129	-0,038	0,959	0,072	-0,037	0,821	0,140	-0,034	0,767	0,144	-0,038	0,821
13	0,648	0,365	0,091	0,661	0,384	0,123	0,684	0,383	0,123	0,538	0,384	0,129	1	0,380	0,129	0,588	0,366	0,157	0,706	0,323	0,218	0,548	0,358	0,074
14	0,389	0,952	-0,046	0,276	0,976	-0,037	0,284	0,981	-0,047	0,196	0,983	-0,038	0,380	1	-0,038	0,322	0,919	0,110	0,280	0,790	0,275	0,404	0,888	-0,046
15	0,202	-0,038	0,889	0,223	-0,039	0,984	0,120	-0,038	0,745	0,254	-0,039	0,959	0,129	-0,038	1	0,072	-0,037	0,871	0,127	-0,034	0,736	0,168	-0,038	0,871
16	0,512	0,347	-0,025	0,647	0,341	0,069	0,619	0,334	0,152	0,639	0,344	0,072	0,588	0,322	0,072	1	0,320	0,137	0,512	0,333	0,191	0,619	0,371	0,039
17	0,393	0,884	-0,044	0,287	0,930	-0,035	0,285	0,884	-0,045	0,205	0,921	-0,037	0,366	0,919	-0,037	0,320	1	-0,045	0,268	0,928	0,201	0,445	0,932	-0,045
18	0,194	0,155	0,760	0,216	0,089	0,866	0,118	0,150	0,635	0,310	0,118	0,821	0,157	0,110	0,871	0,137	-0,045	1	0,138	-0,042	0,780	0,175	0,057	0,759
19	0,561	0,264	0,129	0,555	0,279	0,113	0,677	0,283	0,190	0,592	0,281	0,140	0,706	0,280	0,127	0,812	0,268	0,138	1	0,227	0,198	0,507	0,257	0,042
20	0,363	0,806	-0,041	0,279	0,850	-0,033	0,266	0,774	-0,042	0,225	0,809	-0,034	0,323	0,790	-0,034	0,333	0,928	-0,042	0,227	1	0,103	0,490	0,909	-0,042
21	0,282	0,296	0,708	0,277	0,231	0,684	0,152	0,335	0,590	0,356	0,292	0,767	0,218	0,275	0,736	0,191	0,201	0,780	0,198	0,103	1	0,186	0,272	0,625
22	0,739	0,395	0,107	0,675	0,431	0,177	0,672	0,403	0,221	0,624	0,406	0,144	0,548	0,404	0,168	0,619	0,445	0,175	0,807	0,490	0,186	1	0,463	0,116
23	0,384	0,876	-0,045	0,297	0,926	-0,036	0,281	0,896	-0,047	0,249	0,925	-0,038	0,358	0,888	-0,038	0,371	0,932	0,057	0,257	0,909	0,272	0,463	1	-0,046
24	0,141	-0,046	0,760	0,161	-0,047	0,866	-0,046	-0,047	0,635	0,180	-0,047	0,821	0,074	-0,046	0,871	0,039	-0,045	0,759	0,042	-0,042	0,625	0,116	-0,046	1

Description: 1. Breed (cattle), 2. Breed (goat), 3. Breed (pig), 4. Rearing (cattle), 5. Rearing (goat), 6. Rearing (pig), 7. Cutting (cattle), 8. Cutting (goats), 9. Cutting (pigs), 10. Veterinary/Reproduction (cattle), 11. Veterinary/Reproduction (goats), 12. Veterinary/Reproduction (pigs), 13. Capital Loans (cattle), 14. Capital Loans (goats), 15. Capital Loans (pigs), 16. Palm Oil Land Availability (cattle), 17. Palm Oil Land Availability (Goats), 18. Palm Oil Land Availability (pigs), 19. Forage from crops (cattle), 20. Forage from crops (goats), 21. Forage from crops (pigs), 22. Local community Support (cattle), 23. Local community Support (goats), and 24. Local community Support (pigs).

The correlation matrix can be used in analyzing farmers' perceptions to determine the relationship or link between two or more variables contained in the dataset. The PCC matrix is a statistical measure that measures the degree to which two variables move together or are linearly related. This coefficient can range between  $-1$  to  $+1$ , with a value of  $+1$  indicating perfect positive correlation, a value of  $-1$  indicating perfect negative correlation, and a value of  $0$  indicating no linear correlation between two variables.

In the context of analyzing farmers' perceptions, the correlation matrix (Table 9) can help in understanding the relationship between relevant variables and aspects of farmer perception. Examples of variables that can be correlated include livestock breeding factors with maintenance (cultivation) and the level of livestock health. This can help identify perceived factors that contribute to increased production and can also help in understanding the impact of work ethic/work culture in building sustainable livestock.

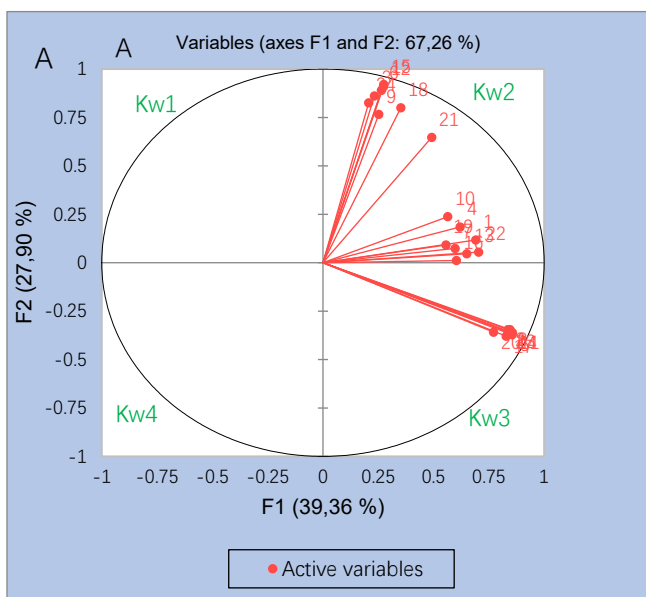

A. Biplot graph of distribution and relationship between variables inside quadrant (Kw) 1-4.

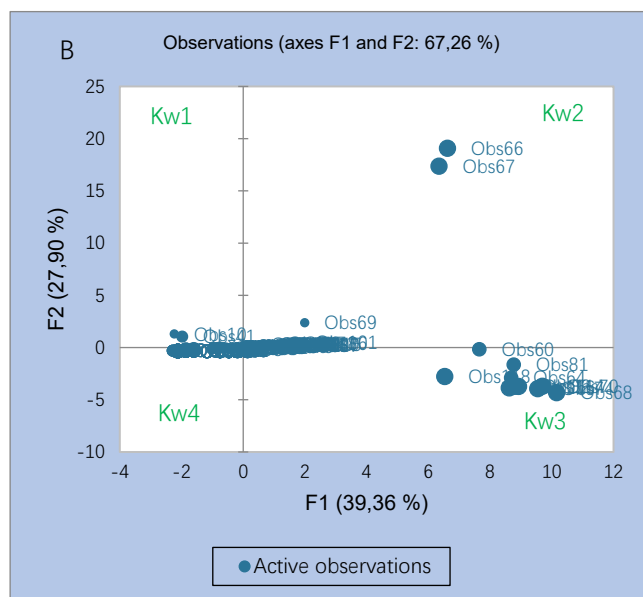

B. Distribution of observation (n=118) on quadrant of Biplot graph.

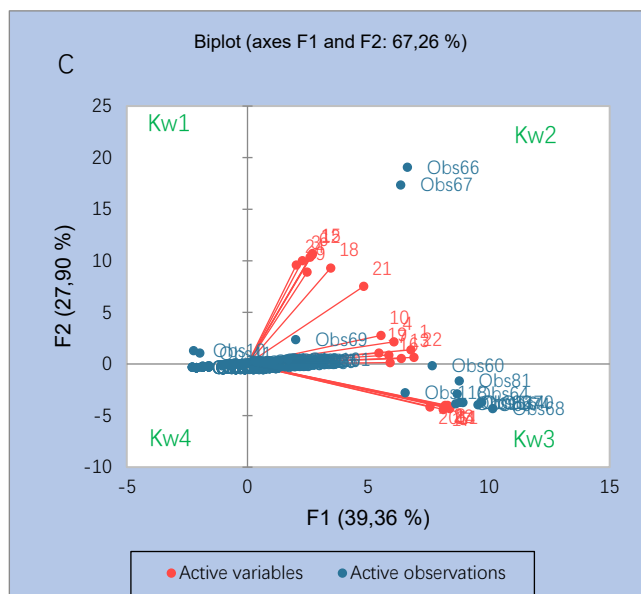

C. Distribution of variables and observation in Biplot graph.

Figure 5. Diagram of Biplot variables and respondents concerning perception.

**Information:** Breed (cattle), 2. Breed (goat), 3. Breed (pig), 4. Rearing (cattle), 5. Rearing (goat), 6. Rearing (pig), 7. Cutting (cattle), 8. Cutting (goats), 9. Cutting (pigs), 10. Veterinary/Reproduction (cattle), 11. Veterinary/Reproduction (goats), 12. Veterinary/Reproduction (pigs), 13. Capital Loans (cattle), 14. Capital Loans (goats), 15. Capital Loans (pigs), 16. Palm Oil Land Availability (cattle), 17. Palm Oil Land Availability (Goats), 18. Palm Oil Land Availability (pigs), 19. Forage from crops (cattle), 20. Forage from crops (goats), 21. Forage from crops (pigs), 22. Local community Support (cattle), 23. Local community Support (goats), and 24. Local community Support (pigs).

Quadrant I (Kw1) is negatively correlated with the F1 axis and positive with the F2 axis (Figure 5A). Quadrant II (Kw2) is positively correlated with the F1 and F2 axes. Quadrant III (Kw3) is positively correlated with the F1 axis and negative with the F2 axis. Meanwhile, Quadrant IV (Kw4) is negatively correlated with F1 and F2. No variables were found distributed in Kw1 and Kw4. In Kw2 there are variables such as 1. Seeds (cattle), 3. Seeds (pigs), 4. Maintenance (cows), 6. Maintenance (pigs), 7. Slaughter, 9. Slaughter, 10. Health/Reproduction, 12. Health /Reproduction, 13. Business Capital Loans, 15. Business Capital Loans, 16. Availability of Palm Oil Habitat, 18. Availability of Palm Oil Habitat, 19. Availability of Feed from Agricultural Land, 21. Availability of Feed from Agricultural Land, 22. Community Support Aspects, and 24. Community Support Aspects. Meanwhile, in Kw3, variables were found such as 2. Seeds (goats), 5. Maintenance, 8. Slaughter, 11. Health/Reproduction, 14. Business capital loans, 17. Availability of palm oil habitat, 20. Availability of feed from agricultural land, 23. Figure 3B shows the distribution of respondents (farmers) in Quadrant 2, 3, and 4 (Figure 5B). Aspects of Community Support. It can be concluded that the variables distributed in Kw2 and Kw3 are relatively uniform (Figure 5C).

#### 4. Discussion

Socio-cultural productivity and farmers' perceptions of the use of public land and oil palm plantation areas are topics that cover several different aspects. In this discussion, we highlight how socio-cultural factors determine the productivity and perceptions of farmers in these two contexts. Socio-cultural productivity refers to the influence of values (Quisumbing, 1996), norms (Firth et al., 2011), and socio-cultural practices (Ayantunde et al., 2011; Molina-Flores et al., 2012) on productivity in a society. In the context of oil palm land use, socio-cultural factors that influence productivity will consist of ages, experiences, and jobs (occupancies). In Table 2, several parameters have strong ( $r > 0.50$ ) and weak ( $r < 0.50$ ) positive correlations and several have negative correlations (Table 4). The example is shown by ages vs experience, experiences vs gender both men (negative) and women (positive).

The maturity of ages and positive perceptions in society will shape how farmers use open land. Experiences and perception awareness can encourage sustainable and innovative agricultural practices, which in turn can enhance productivities. The existence of well-organized farmer groups or working groups can facilitate the exchange of knowledge and resources which can increase productivity and efficiency in the use of open land. This can be done by involving local Socio-cultural factors that can also be reflected in existing institutions and policies. Policies that support good use of open land and respect local knowledge and practices can help in increasing productivities.

In the context of oil palm plantations, socio-cultural productivity plays a significant role. Farmers' knowledge and skills (Kebebe, 2019; Sekaran et al., 2021; Shamna et al., 2018) in cultivating forages and utilizing oil palm land can have a direct impact on productivity. Socio-cultural factors such as planting traditions and cultivation techniques passed down from generation to generation can influence how farmers use oil palm plantation land in proper and better ways for future sustainability. The relationship between farmers and palm oil companies can affect productivity. Good cooperation between farmers and companies, with the fulfillment of farmers' rights and fair distribution of benefits, will then enhance the productivities of farmers and sustain natural resources as assets.

Farmers' perceptions refer to their views and assessments of the use of open land and oil palm plantations. Our findings in this study show breeds, rearing livestock, slaughter livestock, veterinary/reproduction of livestock, capital loans, palm oil land availability, forages from crops, and local community support have a positive correlation. These perceptions can be determined by socio-cultural factors. The first factor is local community support. Their values and beliefs are shaped by age for maturity, experiences for skills, and gender for labor power. These properties have proven significant values both in Table 2 and 7. The values and beliefs held by farmers can determine farmers' perceptions of land use. For example, if breeders have high environmental concerns, farmers/breeders may have a more negative perception of oil palm plantations which can damage the environment. Farmers' personal experience and knowledge (Belay et al., 2022; Hamilton et al., 2020; Ugochukwu & Phillips, 2018) regarding land use can shape and shift farmers' perceptions. If farmers have had positive experiences with oil palm plantations or have seen the benefits gained from well-managed open land, then farmers may have a more positive perception. The social and economic context in which farmers find themselves can also make up their perceptions. Factors

such as access to resources, income level, and dependence on the agricultural sector can shape farmers' perceptions of land use.

In combining these two aspects, it is important to consider socio-cultural factors that have interlinkage the productivity and perceptions of farmers in the use of open land and oil palm plantations. Approaches that respect socio-cultural diversity, strengthen farmer participation (Marandure et al., 2020; Ozcatalbas et al., 2010), and promote sustainable practices can help in achieving high productivity and reducing negative impacts on the interaction between the physical environment of the oil palm land use and local communities.

## 5. Conclusion

From the results of this study, it can be concluded that young ages' farmers tend to have a mindset that is more open to innovation and new technology in animal husbandry. Older farmers may have greater knowledge and experience in traditional livestock practices. Traditionally, animal husbandry has often been seen as gender working oriented which is more commonly carried out by men. However, the role of women in animal husbandry is unbelievably increasing. Women tend to play a role in livestock management, marketing livestock products, or small-scale animal husbandry, while men are more dominant in physical aspects such as livestock care and cage construction. Farmers' goals can vary, including meeting personal consumption needs, and supplying the local market. Experiencing farmers tend to have better knowledge and practical skills in managing livestock and dealing with challenges that may arise. Earlier carrier farmers may need to rely on external resources such as training or consulting to gain the necessary knowledge. Farmers with larger herds may face more complex management and rearing challenges. Farmers with smaller herds may be more flexible and can provide more individual attention to each animal. Farmers' jobs can vary, from farmers who have livestock as additional income to farmers as professional managers farmers who fully manage their livestock. Farmers who work as civil servants, army/po-lice, or private individuals may have different approaches and resources in managing their farms. Farmers who have been farming for a long time may have a better understanding and experience in effective livestock practices and management. In common, several parameters of socio-cultural properties have strong/weak and positive/negative correlations.

Conclusions related to the perception of livestock cultivation which includes selecting quality breeds is an important step in livestock cultivation. Selection of superior cattle, goat, and pig breeds will affect the productivity and quality of livestock products. Perception on rearing livestock includes providing sufficient feed and proper veterinary/reproduction. Perception on slaughtering livestock is important considered as well. Gaining access to business capital loans can help farmers expand or improve livestock farming operations. This loan can be used to buy breed, equipment, feed, and other needs. The availability of oil palm land as grazing land can be a determining factor in selecting a location for livestock rearing. Perception on oil palm land can be a primary source of forages as feeds for livestock. Farmers also perceive a positive impact on the support from customary rights owners and communities in livestock productivities. Their involvement in providing permits, knowledge, and cooperation can help create a conducive environment for developing livestock businesses. In general, like socio-cultural properties, perceptions also have strong/weak and positive/negative correlations.

**CRedit Author Statement:** Deny Anjelus Iyai: Conceptualization, Methodology, Visualization, Investigation, Data curation, Writing – original draft, Writing – review & editing; Ambo Ako: Conceptualization, Methodology, Visualization, Investigation; Yubelince Yustenci Runtuboi: Visualization, Investigation, Writing – review & editing; Sitti Nurani Sirajuddin: Conceptualization, Methodology; Petrus Abraham Dimara: Data curation, Writing – original draft, Writing – review & editing; Budiman Nohong: Conceptualization, Methodology; Amilda Auri: Conceptualization, Methodology, Visualization, Investigation; Novita Panambe: Visualization, Investigation; Stepanus Package: Data curation, Writing – original draft; Nithanel M. H. Benu: Visualization, Investigation.

**Data Availability Statement:** Not applicable.

**Funding statement:** This research received no external funding.

**Conflict of interest:** The authors declare no competing interest.

**Acknowledgment:** The authors thanked all participants from farmers, community leaders, youth leaders, and subdistrict officers for their valuable help and guidance.

## Appendix.

### Questionnaire (Questionnaire)

#### A LIST OF QUESTIONS

Study Title:

## ANIMAL PRODUCTIVITY ON OIL PALM PLANTATIONS IN WEST PAPUA

**Introduction:** My name is Deny Iyai (Lecturer at the Faculty of Animal Husbandry, Unipa Manokwari), currently doing research. We ask for your help and cooperation, Mr. Mrs. Farmer/Breeder in providing relevant data or information. The data from our interviews/observations will not be published to anyone who is not interested. Thank you for your cooperation, sir/madam.

Name of village/lane :

District :

Respondent's Name :

### 1. Breeder characteristics:

- a. Age :..... Yr
- b. Last education:.....
- c. Ethnic group :.....
- d. Purpose of breeding:.....
  1. Business, 2. Social Needs (Education), 3. Pleasure/Hobby, 4. Customary/Cultural Needs
- e. Years of farming:..... Years
- f. Livestock ownership:
  1. Cow: a. child..... tail, b. Juvenile.....tail, c. Main.....tail
  2. Pigs: a. child..... tail, b. Juvenile.....tail, c. Parent.....tail
  3. Goat: a. child..... tail, b. Juvenile.....tail, c. Main.....tail
  4. Ducks: a. child..... tail, b. Juvenile.....tail, c. Main.....tail
  5. Aym kampung: a. child..... tail, b. Teen..... tail, c. Parent..... tail
  6. Sliced Chicken: a. child.....tail, b. Juvenile.....tail, c. Parent.....tail
- g. The main job:
  1. Civil servants, 2. TNI/POLRI, 3. Farmers, 4. Breeders, 5. Private
- h. Breeding experience:.....years (since.....)

### 2. Characteristics of pig farming:

- a. Origin of seeds:
  1. Local Government (Dinas) assistance, 2. Buy it yourself, 3. Mosque/Church assistance, 4. Private Assistance (NGO)
- b. Seed type:
  1. Local, 2. Crossbred (Crossbred), 3. Forest (Wild)
- c. Number of cubs per parent (Liter size):.....heads/parent/yr
- d. Number of births per year (Farrowing rate):.....times/year
- e. Mating system: 1. Natural, 2. Artificial (IB)
- f. Maintenance system:
  1. Without cage, 2. There is a cage, 3. There is a cage and Detachable.
- g. BCS (enter 1: skinny, 2. somewhat fat, 3. very fat):
  1. Cow: a. Livestock....., b. Teenagers ....., c. Parent.....
  2. Goats: a. Livestock....., b. Teenagers ....., c. Parent.....
  3. Pigs: a. Livestock....., b. Teenagers ....., c. Parent.....
- h. Number of livestock that die in a year:.....head
- i. Amount of livestock given to others:.....head
- j. Number of livestock sold:.....head

### 3. Characteristics of animal husbandry

#### A. Cost

1. Fixed Costs:
  - a) Cage Cost: Rp.....
  - b) Cost of work equipment/cage equipment: Rp.....
  - c) Shelf life:..... Years
2. Variable Costs:

- a) Feed Cost: Rp.....
  - b) Cost of Purchasing Animal Medicine: Rp.....
  - c) Paramedic/Veterinary Fee: Rp.....
  - d) Labor Costs:Rp.....
  - e) Cost of Buying Livestock Seeds: Rp.....
  - f) Transportation Fee: Rp.....
  - g) Electricity Cost: Rp.....
- B. Sales:
- a) Sale:
    - 1. Amount sold: a. child.....tail, b. Juvenile.....tail, c. Adult.....tail
  - b) Price sold: a. Children: Rp.....b. Teenagers: Rp.....c. Adult: Rp.....
- C. Acceptance:
- a. Child: Rp.....b. Teenagers: Rp.....c. Adult: Rp.....

#### 4. Feed characteristics

- a. Feed type:
  - 1. Shop Feed, b. Agricultural/Plantation Products, c. Household Leftover Feed
- b. Frequency of administration: a.1 time, b. 2 times, c. 3 times

#### 5. Number of open spaces: .....location

#### 6. Types of open land: a. former garden, b. palm oil, c. roadside, d. field, e. near pond/swamp, f. near the river/river

#### 7. Types of garden residues used: a.sweet potato, b. rice, c. corn, d. peanut leaves, e. long bean leaves, f. others (please specify.....)

#### 8. Marketing Place of sale: a. At home, b. Local market, c. Manokwari City market

#### Perception of Animal Husbandry

- A. Bibit:
- a) Cow breeds: 1. Poor, 2. Average, 3. Good, 4. Very Good
  - b) Goat breeds: 1. Poor, 2. Average, 3. Good, 4. Very Good
  - c) Pig Breeds: 1. Poor, 2. Fair, 3. Good, 4. Very Good
- B. Maintenance:
- a) Cow: 1. Poor, 2. Fair, 3. Good, 4. Very Good
  - b) Goat: 1. Poor, 2. Fair, 3. Good, 4. Very Good
  - c) Pork: 1. Poor, 2. Fair, 3. Good, 4. Very Good
- C. Cutting:
- a) Cow: 1. Poor, 2. Fair, 3. Good, 4. Very Good
  - b) Goat: 1. Poor, 2. Fair, 3. Good, 4. Very Good
  - c) Pork: 1. Poor, 2. Fair, 3. Good, 4. Very Good
- D. Animal health and reproduction services:
- a) Cow: 1. Poor, 2. Fair, 3. Good, 4. Very Good
  - b) Goat: 1. Poor, 2. Fair, 3. Good, 4. Very Good
  - c) Pork: 1. Poor, 2. Fair, 3. Good, 4. Very Good
- E. Capital Loan Policy from Banks/Regional Government:
- a) Cow:1. Poor, 2. Fair, 3. Good, 4. Very Good
  - b) Goat: 1. Poor, 2. Fair, 3. Good, 4. Very Good
  - c) Pork: 1. Poor, 2. Fair, 3. Good, 4. Very Good
- F. Availability of Palm Oil Habitat:

- a) Cow: 1. Poor, 2. Fair, 3. Good, 4. Very Good  
 b) Goat: 1. Poor, 2. Fair, 3. Good, 4. Very Good  
 c) Pork: 1. Poor, 2. Fair, 3. Good, 4. Very Good
- G. Availability of Feed from Agricultural Land/Garden:  
 a) Cow: 1. Poor, 2. Fair, 3. Good, 4. Very Good  
 b) Goat: 1. Poor, 2. Fair, 3. Good, 4. Very Good  
 c) Pork: 1. Poor, 2. Fair, 3. Good, 4. Very Good
- H. Aspects of Community Support for maintenance:  
 a) Cow: 1. Poor, 2. Fair, 3. Good, 4. Very Good  
 b) Goat: 1. Poor, 2. Fair, 3. Good, 4. Very Good  
 c) Pork: 1. Poor, 2. Fair, 3. Good, 4. Very Good
- I. Inhibiting Factors:  
 a) Anything for Cattle: .....  
 b) Anything for Goat farming:.....  
 c) Anything for Pig farming.....

Closing: That's how we collected the data. On behalf of the Dean of the Faculty of Animal Husbandry, Unipa Manokwari and as a researcher, we would like to thank you very much for your good cooperation. Greetings.

Manokwari,

2022

Researcher

Deny A. Iyai

## References

- Aritonang, S. Roza, E., & Tama, S. H. (2019). The potentials of palm oil plantation wastes as animal feed at traditional farming in Teras Terunjam Subdistrict Muko-Muko District. *Jurnal Ilmu Ternak Universitas Padjadjaran*, 18(2), 95–103. <https://doi.org/10.24198/jit.v18i2.20757>
- Ayantunde, A. A., de Leeuw, J., Turner, M. D., & Said, M. (2011). Challenges of assessing the sustainability of (agro)-pastoral systems. *Livestock Science*, 139(1–2), 30–43. <https://doi.org/10.1016/j.livsci.2011.03.019>
- Belay, A., Oludhe, C., Mirzabaev, A., Recha, J. W., Berhane, Z., Osano, P. M., Demissie, T., Olaka, L. A., & Solomon, D. (2022). Knowledge of climate change and adaptation by smallholder farmers: Evidence from Southern Ethiopia. *Heliyon*, 8(12), Article e12089. <https://doi.org/10.1016/j.heliyon.2022.e12089>
- Bell, L. W., Moore, A. D., & Thomas, D. T. (2018). Integrating diverse forage sources reduces feed gaps on mixed crop-livestock farms. *Animal*, 12(9), 1967–1980. <https://doi.org/10.1017/S1751731117003196>
- Boogaard, B. K. (2009). *The Socio-Cultural Sustainability of Animal Farming : An Inquiry into Social Perceptions of Dairy Farming in the Netherlands and Norway*(Publication No. 28237760). [Doctoral dissertation, Wageningen University]. ProQuest Dissertations and Theses Global.
- Campos, M., Velázquez, A., & McCall, M. (2014). Adaptation strategies to climatic variability: A case study of small-scale farmers in rural Mexico. *Land Use Policy*, 38, 533–540. <https://doi.org/10.1016/j.landusepol.2013.12.017>
- Le Thi Minh, C., Lebailly, P., & Tran Quang, T. (2017). Enhancing farmers' market power and income in the pig value chain; a case study in Bac Giang province, Vietnam. *Livestock Research for Rural Development*, 29(12), 13.
- Cortner, O., Garrett, R. D., Valentim, J. F., Ferreira, J., Niles, M. T., Reis, J., & Gil, J. (2019). Perceptions of integrated crop-livestock systems for sustainable intensification in the Brazilian Amazon. *Land Use Policy*, 82, 841–853. <https://doi.org/10.1016/j.landusepol.2019.01.006>
- Dady, Z., Kaunang, C. L., & Tulung, Y. L. R. (2018). Potensi pengembangan Ternak sapi potong dengan pola integrasi kelapa-sapi di Kecamatan Tabaru Kabupaten Halmahera Barat. *Agri-Sosioekonomi*, 14(1), 335–346. <https://doi.org/10.35791/agrsosek.14.1.2018.19557>
- Ediset, E., Jaswandi, J., Heriyanto, E., & Basyar, B. (2017). Peningkatan produktivitas Peternak sapi di daerah transmigrasi Lubuk Aur Sitiung I Kabupaten Dharmasraya. *LOGISTA - Jurnal Ilmiah Pengabdian Kepada Masyarakat*, 1(1), 11–19. <https://doi.org/10.25077/logista.1.1.11-19.2017>
- Far, Z., & Yakhler, H. (2015). Typology of cattle farming systems in the semi-arid region of Setif: Diversity of productive directions. *Livestock Research for Rural Development*, 27(6), 2015.
- Firth, C., Maye, D., & Pearson, D. (2011). Developing “community” in community gardens. *Local Environment*, 16(6), 555–568. <https://doi.org/10.1080/13549839.2011.586025>
- Hamilton, H., Henry, R., Rounsevell, M., Moran, D., Cossar, F., Allen, K., Boden, L., & Alexander, P. (2020). Exploring global food system shocks, scenarios and outcomes. *Futures*, 123. <https://doi.org/10.1016/j.futures.2020.102601>
- Hosseini, M., Shahrabak, H. M., Zandi, M. B., & Fallahi, M. H. (2016). A morphometric survey among three Iranian horse breeds with multivariate analysis. *Media Peternakan*, 39(3), 155–160. <https://doi.org/10.5398/medpet.2016.39.3.155>
- Iyai, D. A., Marani, O., Marjen, T., & Usior, L. (2013). Pig farming performances of three Papuan tribes: Case study of Byak, Onate and Arfak Tribes in Papua Barat. *Journal of the Indonesian Tropical Animal Agriculture*, 38(1), 55–64. <https://doi.org/10.14710/jitaa.38.1.55-64>
- Kauber, K., Fowler, H., Lipton, B., Meschke, J. S., & Rabinowitz, P. (2017). Salmonella knowledge, attitudes and practices: A survey of backyard poultry owners residing in Seattle, Washington and the surrounding metropolitan area. *Zoonoses and Public Health*, 64(1),

- 21–28. <https://doi.org/10.1111/zph.12274>
- Kauppinen, T., Valros, A., & Vesala, K. M. (2013). Attitudes of dairy farmers toward cow welfare in relation to housing, management and productivity. *Anthrozoos*, 26(3), 405–420. <https://doi.org/10.2752/175303713X13697429463718>
- Kebebe, E. (2019). Bridging technology adoption gaps in livestock sector in Ethiopia: A innovation system perspective. *Technology in Society*, 57, 30–37. <https://doi.org/10.1016/j.techsoc.2018.12.002>
- Marandure, T., Dzama, K., Bennett, J., Makombe, G., Chikwanha, O., & Mapiye, C. (2020). Farmer challenge-derived indicators for assessing sustainability of low-input ruminant production systems in Sub-Saharan Africa. *Environmental and Sustainability Indicators*, 8. <https://doi.org/10.1016/j.indic.2020.100060>
- Molina-Flores, B., Velasco, G., Loza, S., & Soliman, I. (2012). Socio-cultural factors determining roles and responsibilities in traditional cattle production systems within rural communities of Upper Egypt. In I. Casasús, J. Rogoš, A. Rosati, I. Štokovič, & D. Gabiña (Eds.), *Animal farming and environmental interactions in the Mediterranean region* (pp. 241–247). Wageningen Academic Publishers. [https://doi.org/10.3920/978-90-8686-741-7\\_30](https://doi.org/10.3920/978-90-8686-741-7_30)
- Mukhopadhyay, D. (2009). Cultural values, indigenous knowledge for climate change adaptations in developing countries. *IOP Conference Series: Earth and Environmental Science*, 6(57). <https://doi.org/10.1088/1755-1307/6/7/572006>
- Ozcatalbas, O., Akcaoz, H., Firat, M. Z., & Kutlar, I. (2010). The analysis of socio-economic factors in the dairy farming of Antalya Province of Turkey. *Journal of Animal and Veterinary Advances*, 9(1), 20–26.
- Paris, T. R. (2002). Crop-animal systems in Asia: Socio-economic benefits and impacts on rural livelihoods. *Agricultural Systems*, 71(1–2), 147–168. [https://doi.org/10.1016/S0308-521X\(01\)00041-5](https://doi.org/10.1016/S0308-521X(01)00041-5)
- Pasandaran, E. (2006). Alternatif Kebijakan Pengendalian Konversi Lahan Sawah Beririgasi Di Indonesia. *Jurnal Litbang Pertanian*, 25(4), 123–129.
- Patel, S. J., Patel, J. H., Patel, A., & Gelani, R. N. (2016). Role of women gender in livestock sector: A review. *Journal of Livestock Science*, 7, 92–96. <https://livestockscience.in/wp-content/uploads/gender-livestock.pdf>
- Praza, R. (2016). Optimalisasi cyber extension dalam pembangunan pertanian di era Mea. *Prosiding Seminar Nasional BKS PTN Wilayah Barat Bidang Ilmu Pertanian*, 200–204. [http://repository.unimal.ac.id/2913/1/Optimalisasi Cyber Extension Dalam Pembangunan.pdf](http://repository.unimal.ac.id/2913/1/Optimalisasi%20Cyber%20Extension%20Dalam%20Pembangunan.pdf)
- Quisumbing, A. R. (1996). Male-female differences in agricultural productivity: Methodological issues and empirical evidence. *World Development*, 24(10), 1579–1595. [https://doi.org/10.1016/0305-750X\(96\)00059-9](https://doi.org/10.1016/0305-750X(96)00059-9)
- Sekaran, U., Lai, L., Ussiri, D. A. N., Kumar, S., & Clay, S. (2021). Role of integrated crop-livestock systems in improving agriculture production and addressing food security – A review. *Journal of Agriculture and Food Research*, 5. <https://doi.org/10.1016/j.jafr.2021.100190>
- Shamna, A., Biswas, P., Jha, S. K., Sarkar, S., & Kumar, S. (2018). Tribal farm women’s participation in agriculture and factors influencing it: Evidence from West Bengal, India. *Journal of Agricultural Science and Technology*, 20(5), 911–922.
- Shikuku, K. M., Winowiecki, L., Twyman, J., Eitzinger, A., Perez, J. G., Mwongera, C., & Läderach, P. (2017). Smallholder farmers’ attitudes and determinants of adaptation to climate risks in East Africa. *Climate Risk Management*, 16, 234–245. <https://doi.org/10.1016/j.crm.2017.03.001>
- Sudirman, A., Amrullah, A. & Hamdani, A. (2021). Model pengembangan ternak ruminansia di lahan kering untuk mendukung sektor peternakan di kabupaten Sumbawa. *Jurnal Riset Kajian Teknologi Dan Lingkungan*, 4(2), 268–280.
- Suradisastra, K., & Lubis, A. M. (2000). Aspek gender dalam kegiatan usaha peternakan. *Jurnal Wartazoa*, 10(1), 13–19.
- Ugochukwu, A. I., & Phillips, P. W. B. (2018). From Agriscience to Agribusiness. In N. Kalaitzandonakes, E. Carayannis, E. Grigoroudis, & S. Rozakis (Eds.), *Technology Adoption by Agricultural Producers: A Review of the Literature* (pp. 361–377). Innovation, Technology and Knowledge Management. [https://doi.org/10.1007/978-3-319-67958-7\\_17](https://doi.org/10.1007/978-3-319-67958-7_17)



## Article

# The Effect of Covid-19 on Rural Sport: A Case Study of Endurance GB

Julie Jones Aberystwyth Business School, Aberystwyth University, Aberystwyth, SY23 3DZ, UK; [Jum1@aber.ac.uk](mailto:Jum1@aber.ac.uk)

**Abstract:** The Covid-19 pandemic affected virtually every country in the world and many people's lives. This research investigates the effect of Covid-19 on rural sports in the UK, specifically on the equestrian sport of endurance. Maslow's hierarchy of needs is used to determine levels of emotional investment pre, during, and post Covid. Contrary to the upward trend of consumer spending on recreation over the past five years (Statista, 2022), Endurance GB paid membership has declined year on year with a large drop in 2020 as lockdowns hit the UK according to Endurance GB membership data. This was combined with questionnaires sent out to all current Endurance GB members in September 2021. Respondents were asked about how Covid-19 had affected the continuance of their sport. The results showed that 81% planned to join as normal next year but 18% were keeping an open mind and would re-join when things were back to normal. Secondary ride and membership data for 2022 showed that membership was tracking in line with 2019 and early season rides were full, indicating as much enthusiasm for the sport as there was pre-Covid. However, by mid-season memberships had dropped slightly and ride entries were lower than expected. Some membership patterns changed, with a large increase in registered supporters and riders doing pleasure rather than competitive rides. During Covid focus dropped from "belonging" to "safety and security" (Maslow's hierarchy of needs), with the higher needs becoming redundant.

**Keywords:** Endurance GB; Covid-19; rural sport; equestrian sport

**Citation:** Jones, J. The Effect of Covid-19 on Rural Sport: A Case Study of Endurance GB. *Agricultural & Rural Studies*, 2024, 2, 2.  
<https://doi.org/10.59978/ar02020011>

Received: 18 January 2024  
Revised: 2 April 2024  
Accepted: 19 April 2024  
Published: 30 May 2024

**Publisher's Note:** SCC Press stays neutral with regard to jurisdictional claims in published maps and institutional affiliations.



**Copyright:** © 2024 by the author(s). Licensee SCC Press, Kowloon, Hong Kong S.A.R., China. The article is an open access article distributed under the terms and conditions of the Creative Commons Attribution (CC BY) license (<https://creativecommons.org/licenses/by/4.0/>).

## 1. Introduction and Background

### 1.1. The Impact of Covid-19 on Sports

Covid-19 has had an unprecedented effect around the globe, and one area affected is sport and leisure (Dashper & King, 2021). All types of sports make an important contribution to the well-being of people around the world—emotionally, physically, and psychologically. The effect of lockdowns and no sports have had a detrimental effect on global communities, with the resumption of sports contributing significantly to normality being resumed (Hughes et al., 2020), however, it is widely acknowledged that this is likely to take many months with organisations with more than 25% of ethnically diverse members forecasting longer negative impacts from Covid lockdowns (Barrett & Coleman, 2021).

There is a growing corpus of global research emerging in this area, for example, the USA (DiFiori et al., 2021), Australia (Hughes et al., 2020), and Greece (Madininos et al., 2021).

The effect is not just at the elite level, but at the grassroots, with the initial lockdown in the UK stopping most indoor and outdoor sports within the country. Sports that did take place did so with no spectators and often a much-reduced number taking part—for example, the London Marathon in 2020 (Grix et al., 2020).

Given the suspension of sporting activities, many sports bodies are concerned about the numbers of people resuming their sport post-pandemic and the challenges faced (Skinner & Smith, 2021). It must be noted that Covid is still in existence in 2023, with new variants causing spikes and short lockdowns worldwide. Given this, it is not known when it will be finally over (Madininos et al., 2021).

The economic impact of Covid-19 on sports globally is unprecedented, with losses of billions of USD and Euros attributed to professional sports in Europe and the USA (Skinner & Smith, 2021). The impact on grassroots sports was similar with many clubs and societies concerned about the future, despite the contradiction that exercise became more important during lockdowns. Many governing bodies are reacting in different ways to the pandemic (Skinner & Smith, 2021). Several

sports are run by volunteers (this is true at the grassroots in particular), often as part of the national governing body (as with Endurance GB) and within complex structures. Even before the pandemic, many sporting communities and clubs were challenged by recruiting not only members but volunteer officials for the sport (Staley et al., 2021). Since the initial UK lockdown in early 2020, member recruitment has been front of mind for many sports officials as they work hard to return their sports to the pre-covid level—particularly at the grassroots level (Grix et al., 2020).

The return to organized sport (particularly amongst the young) was mooted to be slow due to restricted interactions with peers during lockdown and the increase of online activity (particularly gaming) during the same period. Non-organized sporting contexts are more likely in the short to medium term for the youth cohort particularly (Teare & Taks, 2021).

Sport is a vitalizing force that brings people together, producing a sense of uplift and engagement with others, forming like-minded communities (Grix et al., 2020). The lack of this engagement, coupled with the economic difficulties brought about by Covid-19 (particularly amongst the lower socio-economic groups) means that grassroots sports will find it difficult to come back to pre-Covid heights, and the participants and communities may find it hard to engage at their former levels (Grix et al., 2020). Outdoor spaces, closed to many during lockdown are a vital part of health and well-being, and help people to identify who they are by the sports and leisure pursuits undertaken in those spaces (Dashper & King, 2021), compounding the lack of engagement and community since closure. Although many are now fully open, the return to pre-Covid engagement levels is slow as some people have lost the habit of taking part in regular organized sports in these outdoor spaces (Dashper & King, 2021).

Given these considerations, it is understandable that some people ended their memberships in sports and societies, or at least reduced time within their chosen activities (Grix et al., 2020). However, this short-term view could potentially lead to the demise of several societies and sports, precluding the return to pre-Covid levels of engagement and competition. Therefore, there are several challenges that entities face (especially at the grassroots level) post Covid-19. These include financial, community, re-engaging activities for volunteers and participants, and a focus on the community rather than training/competitive aspects (Staley et al., 2021). Rural communities are likely to have longer-term benefits from Covid-19 as new behaviors caused by the pandemic (such as working from home) remain in some form (Phillipson et al., 2020) and this could be a positive boost to rural sports organisations as members have more time to interact with their sports and pastimes.

### 1.2. Hierarchy of Needs

Sport is based on a series of motivations and constructs, including risk-taking, physical fitness, self-esteem, competition, achievement, and self-actualisation (McDonald et al., 2002). A number of these constructs are evident amongst the higher levels of Maslow's hierarchy of needs, namely "love & belonging", "esteem" and "self-actualisation" (Maslow, 1968). According to McDonald et al. (2002), the community side of sport, social interaction, and acceptance by peers as well as family and friends being present can motivate participants to improve their performance (McDonald, 2002).

There is an argument that during Covid, these levels became much less important and difficult to attain given lockdowns, and therefore the lower levels of "physiology" and "safety" became paramount for the population. It was hard to get to shops for food and clothing, and health security was top of mind. It was therefore difficult to move upwards in the hierarchy as the lower levels were not met, affecting people's behaviours (Stowe et al., 2022).

This correlates with Dashper and King (2021), Grix et al. (2020) and Staley et al. (2021) as behaviour patterns are slow to change back to pre-Covid levels, and people's attitudes change towards the situation, allowing them to start to think more about the esteem and self-actualisation levels of the hierarchy again. Love and belonging were engaged throughout Covid as people were in family "bubbles" or were concerned about family members who were not with them (Stowe et al., 2022), however, it can be argued that some of the friendship ties were loosened, particularly within the sporting context as focus changed during lockdowns.

### 1.3. The Research Question

This research aims to understand how Covid has affected membership numbers for rural sports as well as engagement with the sports. There are a wide number of rural sports, whether team or individual. Equestrian sports are predominantly rural by their very nature and within equestrianism there are a number of disciplines. Given this, endurance was chosen as a typical example of a rural sport that engaged widely with the environment and had a membership almost exclusively within rural areas in the UK. Therefore, this study investigates the impact of Covid on endurance riding in England and Wales (this is the area covered by Endurance GB), predominantly the attitude and behavioural changes from members during and post-pandemic. Maslow's hierarchy of needs is used to aid the examination of motivational factors for sports participants in this period.

#### 1.4. Endurance Riding

Endurance is an inclusive equestrian discipline where riders of all ages, ethnicities, abilities, and orientations compete equally on horses and ponies of all types and breeds. This is done across natural terrain courses between 16 and 160km in length (usually in one day) in a test of condition and stamina (Valev, 2015). Training horses to compete over these distances takes time and effort and must be done correctly for the welfare of the horses (Fleming et al., 2013). Although fully inclusive, as with most equestrian disciplines, there is a majority of females competing although males are represented to a lesser degree (typically there are around 80% females to 20% males competing in equestrian sports (Wolframm & Meulenbroek, 2012)).

Taking equestrian sports and general horse riding within the UK, a major study by the British Equestrian Trade Association in 2019 shows that although the steady decline of riders overall, appears to be recovering, there is a large drop in horse numbers (Jones, 2019) and it is within this backdrop that the study takes place.

The lockdowns and restrictions on travel and time to exercise during the worst of Covid often impacted training, and this was exacerbated by a lack of competitive events. Riders often chose not to train to lessen the risk of accidents and the knock-on effect on the already overstretched NHS (see research results) – particularly in the initial lockdowns. As training is often done alone, the risk of getting or spreading Covid-19 was small but access to suitable open spaces was often curtailed (Dashper & King, 2021), both for training and events themselves which were canceled during lockdowns, with some landowners (such as Natural Resources Wales and the Forestry Commission—both important venue owners for Endurance GB) closing their properties to organised sport in 2020 and most of 2021. Other issues included changes to legislation at short notice which resulted in entry limits being imposed and entries being rejected from people in local lockdowns, often at short notice before events.

During this period, many owners were restricted to simply caring for their horses, particularly if they were in livery stables out of the small travelling radius imposed by the government during lockdowns. Affordability was also a consideration as well as the breakdown of the support network around caring for the animals (veterinarian, farrier, etc.) (Ward et al., 2021). The lack of normal positive interactions between owners and their horses led to negative wellbeing for people and time with their horses was valued more when lockdowns eased. The use of social media changed as those who did ride did not post their rides as normal, as they were aware that many either could not ride or had chosen not to because of potential accidents and NHS impact (Ward et al., 2021).

Within endurance riding the bond between horse and rider is important as riders spend many hours riding across all terrains (both in training and competition), and mutual trust is a factor in success (Wolframm & Meulenbroek, 2012).

Endurance is by its nature a rural sport and most participants live in rural areas across the UK, many with their own facilities to keep their horses at home (68% of UK horse owners keep their horses at home, and owners are happy to travel up to 2 hours each way to compete, returning on the same day (Boden et al., 2013). Covid, therefore, had the opportunity to have a large negative effect on endurance riding, not only in the UK but internationally.

## 2. Methodology

Data was collected from members and used alongside secondary data provided by Endurance GB. This dataset included ride entries over 5 years, membership statistics, and trends pre and during Covid. The 2022 membership re-joining and rides data was important in understanding behavioral versus attitudinal information.

Primary data was gathered from a questionnaire sent out to members in September 2021. A representative sample of 141 responses from 1103 members was collected. This data was both quantitative and qualitative. Both primary and secondary datasets were analysed using Excel and Power BI and the qualitative data was used to correlate trends and provide thick description. In March 2022 three short informal interviews were held with long-term Endurance GB members and riders to gauge their interest for the coming year.

This is a piece of reflexive research as the author is an endurance rider and member of Endurance GB, therefore anecdotal and observational data were also used from social media posts (Facebook) and interactions with fellow riders to extend secondary and primary data.

Therefore, the phases of the study were:

Secondary data collection and analysis. Outputs used to develop questionnaire.

Survey sent out to all Endurance GB members in September 2021, responses analysed.

Informal interviews were held with competitors during the first Post-Covid event in the midlands.

Anecdotal and observational data were gathered during competitions over the 2022 and 2023 seasons.

Further analysis of 2022 and early 2023 membership data to track behaviour and attitude from members.

### 3. Data Analysis

#### 3.1. Membership Data

The full membership of Endurance GB has been slowly declining since 2017 from 1715 to 1303 in 2021, against a trend of increasing consumer spending on recreation and sport in the UK, which rose from £7.6bn in 2005 to £12bn in 2019 (Satista, 2022). However, in the same period, supporter membership (free) increased from 1482 to 3935 (see Table 1). Paid members can enter competitive and graded rides, but registered supporters (registered on the Endurance GB website but not paid members) can only enter pleasure rides on a temporary day membership (unless taking part in offers such as “Try Before You Buy” where they can try out up to 2 graded rides before joining as a full member).

Full (paid) memberships dropped by 15% at the onset of Covid (2020) and a further 2% in 2021—against a year-on-year drop of 5% between 2018 and 2019. Covid certainly had some effect on paid membership, but it was temporary as can be seen in the next section below. The large increase in registered supporters gives the Endurance GB marketing team the opportunity to deliver campaigns to convert these to full members.

**Table 1.** Summary of Membership Data by UK Region (England and Wales) from 2017 to 2021.

<b>Full (Paid) member regional summary</b>						
	2017	2018	2019	2020	2021	<b>2021%</b>
Wales	100	88	132	84	80	6.10%
South	660	618	603	492	465	35.70%
Midlands	528	523	456	443	478	36.70%
North	427	416	378	316	280	21.50%
	1715	1645	1569	1335	<b>1303</b>	
<b>Supporter/Club member regional summary</b>						
	2017	2018	2019	2020	2021	<b>2021%</b>
Wales	93	47	115	163	308	7.80%
South	749	416	882	895	1324	33.60%
Midlands	382	171	608	845	1335	34%
North	258	215	507	613	968	24.60%
	1482	849	2112	2516	<b>3935</b>	

Source: Endurance GB 2022.

Different areas of the country were affected by different local Covid restrictions as well as reliance on sensitive landowners such as Forestry England. Some regions (e.g. Midlands) were not as impacted as others and actually grew their paid membership over the course of the pandemic. Others were badly hit with restrictions (e.g. Wales who lost most of their ride venues). Some of the regional committees had many vulnerable households within their members and were limited in what they could offer, with the loss of competitive events. All of these adversely affected membership numbers.

The half-yearly paid membership figures from 2021 and 2022 (earlier years and 2023 were not available) show that there was a year-on-year growth for associate members, in particular junior members (which doubled). Full members had also grown in all areas apart from young riders which was 11% down on the previous year. Junior full members had also doubled. This is encouraging for the future of the sport although Junior numbers are less than 5% of Senior rider membership (the highest category in numbers). Veteran rider numbers (over 60 years of age) are around 50% of Senior rider numbers (203 Veterans and 571 Senior—total 774 full members over 25 years of age), which shows the skew towards older riders within the sport (Young rider numbers are around 13% of Senior rider numbers). When viewing subscription revenues, those of 2022 are £12,000 (rounded) above the 2021 half-yearly figure but £20,000 (rounded) below the pre-Covid 2019 half-yearly figure.

Although marketing has been in place for many years there was a renewed effort from Endurance GB in the aftermath of Covid, but this did not start until March 2022 so does not affect the

2022 membership data above. It was expected that the campaigns in place would increase the 2023 subscription revenues and stop the downwards trend of paid members (see Table 1 above) but early indications show that there was still a small decline in memberships in 2023.

### 3.2. Ride Data

There were 106 rides in the calendar for 2020. These were a mix of Federation Equestre Internationale (FEI), national and group rides. 47 of these were cancelled due to Covid lockdowns and the other 59 went ahead but with very limited entry numbers. In 2021 there were 159 rides in the calendar—134 went ahead and 25 were cancelled. Again, few of those that went ahead were full (attained the maximum riders allowed at the venue), despite the calendar being almost back to normal. 2022 had 98 rides to the end of June (mid-season) with 85 going ahead and 13 being cancelled. There are a further 58 rides from July to the end of the season with 3 being canceled (as at end of June). Rides that have closed their entries are not full as at the access date of 30<sup>th</sup> June of the ride calendar (For example, Cirencester, a major ride over 3 days, hosting the inter-regional championships closed with only 60% of expected riders, including 86 withdrawals at late notice (ride entry data)). The ride cancellations in the calendar were not always directly attributed to Covid but often due to a lack of entries, bad weather, or lack of volunteers. Indirect Covid reasons include loss of venues, at times due to them being sold during the pandemic. In 2023 there was a full calendar, but some rides were cancelled due to lack of entries or difficulties with venues—however, this was a “normal” number.

Many horses were still not fully competition fit in 2022 due to the previous years’ lockdowns and cancellations—particularly those competing at longer distances where a long interruption in training has a bigger impact (observational data). Previous Endurance GB research has shown that it takes around 4 years of training for a horse to get to FEI level, so a 2-year gap in training is a big setback. Those able to maintain fitness over the pandemic were more successful. Some horses competed at shorter distances than usual to regain fitness and can be seen starting to get back to their “normal” ride distances in the second half of 2022 (observational data). However, the FEI competitors are taking longer to get back to full fitness therefore FEI rides are lacking entries in the first half of 2022 with non-completions from some who do enter (Endurance GB data), this carried over into 2023.

Trend data from 2012 to 2022 (for the first 2 months of each season) shows that there is an overall slow decline in riders competing each year (see Figure 1 below) after a growth between 2013 and 2015. The large drop in 2020 and 2021 is due to Covid but the numbers have risen in 2022 almost to where they would have been expected to be without Covid. This shows that not only are rides being held again, but that riders feel that they and their horses are fit enough to enter after a long break. Note that rides early in the season tend to be shorter distances (usually up to about 50K) so horse and rider fitness is easier to achieve.

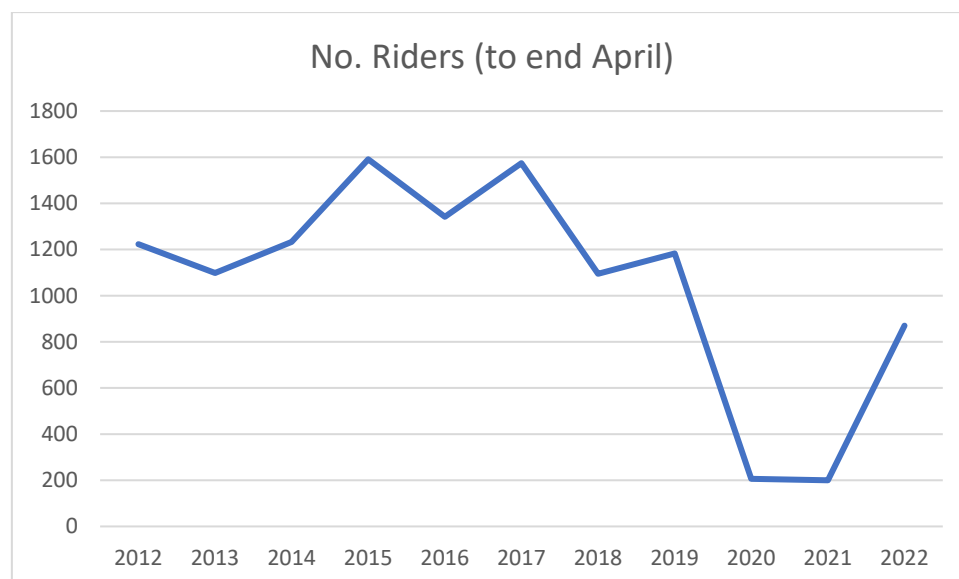

**Figure 1.** Number of riders in England and Wales competing in March/April each year.

**Source:** Author’s own work from trend data (2023 unavailable)

### 3.3. Demographic Survey Data

Of the 141 respondents, there were 129 females and 10 males with 2 preferring not to give their gender. Nine of the males were 45 and over and so were 80% of the females (correlating with the secondary membership data regarding ages as the survey was open only to people 18 and over so Junior riders were precluded). 85% of respondents were from England, 16% from Wales, and 1 each from Scotland and Northern Ireland. Three respondents did not give regional information. Eighty-three respondents were in full or part-time work and 44 were retired. The remainder were in education, volunteering, or home makers. Household incomes had largely remained the same or increased during the 2 years of Covid (80%).

There were 92 full-riding members, 9 life members, 18 associate members, and 6 non-riding members. The remainder were supporters (7), lapsed (6), or other (3), and of these, only 3 had held a paid membership. Of the paid members 59% had been members for 5 years and above with a further 8% holding memberships for over 20 years. 23% had held their memberships for less than 5 years. The remainder did not say. This data was from September 2021 and 77% planned to rejoin within a month of the reminder coming out, and a further 9% when they entered their first ride. Only 3 people said they would not renew, but 5 declined to answer. 91% of households had one or two full members.

Only 3 respondents did not have their own horse. 72% had between 1 and 3 horses and a further 15% had 4 or 5. The Welsh respondents mainly kept their horses at home (82% with 18% in livery) whilst the English respondents had a more even split with 59% kept at home and 41% in livery. Regarding the number of horses each respondent used for endurance, 109 had one or two in training and 13 had 3. Five had 4 and one each had 5, 6, or 7. Eight respondents had no horses doing endurance and 3 respondents did not have a horse. 40% of horses owned had some Arabian blood (pure or part bred) and this increased to 57% amongst those doing endurance.

89% of respondents were currently riding in endurance at different levels: 29% Pleasure Riding, 21% Novice, 20% Open, 22% Advanced, and 7% International (under FEI rules). Advanced Riders compete at 80km or above and International 100km and above. The other levels range from around 20km to 65km distance. 33% of riders only rode up to 30km, 32% 31 to 44km; 19% 45 to 79km; and 16% 80km and over. This correlates with distances offered at rides as the majority of national rides offer up to 45km, with major rides offering a full range of national rides (22 to 80km) but very few offering FEI level rides, and most of these are in the East of the UK (Suffolk, Lincolnshire, etc.).

94% of respondents have a competitive ride within 50 miles of where they live, however, many riders (58%) regularly travel up to 100 or 150 miles to compete, with 25% of riders saying they would travel over 200 miles if necessary. The top three favorite rides were Red Dragon in Wales (12%), Kings Forest in Suffolk (10%), and Golden Horseshoe on Exmoor (8%). Red Dragon and Golden Horseshoe are considered to be “true” endurance rides given the hilly terrain and often difficult weather conditions encountered. Fourteen percent of respondents did not have a favorite ride.

Crews are mandatory for longer distances (they meet the rider at different points on the ride, offering drinks and food to both horse and rider and “sloshing” the horse with water to cool it down) but not for shorter distances (40K and under). However, 48% of respondents had a regular crew (covering all distances ridden), and 59% of these were spouses/partners. Other family members and friends made up the other 41%. 45% of riders often rode without a crew. Crews also help with the horses at the venue and can drive there and back, allowing the rider to concentrate energy on the ride.

This demographic data showed a spread of riders, horses, and events across England and Wales and paints a fairly healthy picture of memberships and support for the sport.

### 3.4. Covid Survey Data

66% of riders competed in between 1 and 10 events in 2019 before Covid; this dropped to 50% in 2020 and rose to 69% in September 2021 with a further 69% planning between 1 and 5 rides before the end of the 2021 season (mid-October).

Covid altered the training of horses in different ways. 40% of riders reported little or no change, 26% reduced their riding and 13% did not ride in the first lockdown in case they got hurt and negatively impacted the NHS. 18% stopped training as there were no events. Covid impacted in other ways as riders could not travel their horses to train, could not visit livery yards, or hire training facilities. A small number had time to ride more (3%), and others (8%) changed the way that they trained (riding more at home, schooling, safer rides, and so on). A further 4% did not ride as much due to shielding or having Covid themselves. Finally, 6% of members work in the NHS and during Covid were too busy to ride as they worked longer hours.

Covid did not affect the majority of members re-joining in 2021 with 80% joining as normal (comments included “if we don’t join there won’t be a sport to come back to after Covid”). Five

people said they would join in 2022 or after Covid. Two joined for the insurance cover. Sixteen people said that Covid affected their membership and had not re-joined as there was no point. Comments from these riders included— *“I have lost my competitive spirit”* and *“I can’t get my horse fit so am not bothering coming back into the sport”*.

Covid affected 68% of the respondents as far as endurance is concerned. The main reasons were fewer events (31%), so training was reduced and therefore horse and rider fitness levels dropped. This resulted in a loss of motivation to ride which affected overall intentions to join and compete in 2022. However, 90% of respondents planned to rejoin in 2022 with only 3% saying they would not, and 7% were undecided. A small percentage of respondents were staying involved with the sport by volunteering but not riding and others were downgrading just to pleasure rides or fun rides (non-Endurance GB) (2% for each category).

Respondents were asked for further comments on how Covid had affected their endurance and only 53% answered. 16% appreciated the way that Endurance GB had handled the pandemic, but others were unhappy about the lack of rides (4%) and felt let down (4%). One respondent appeared to take a balanced view, commenting: *“Covid has brought out the very best and the very worst in people. The vast majority of members have been very understanding and have really pulled out all of the stops to support the organisation in whatever way they can. I am concerned that some of the areas of the country most badly affected (e.g. Wales, the North) will take longer to recover as their ability to hold rides was decimated by the impact of the virus on their local areas. There has also been a terrible impact on international competition, and some of the people affected haven’t seemed to understand at times that this is completely outside of EGB’s control. There is also a small pocket of people who think it is all an over-reaction and that EGB should have ignored all the government restrictions and carried on regardless”*.

### 3.5. Interview Data

The interviewees had been endurance riders for over 20 years and members of Endurance GB since its inception with few or no breaks. All are advanced riders, and one has competed internationally for Britain. Until 2020 all competed regularly within the UK. All are women over 50 years of age and from a single regional group in Wales (an area with many restrictions during Covid and few rides).

Interviewee one terminated her membership at the end of 2019 (pre-Covid) citing that she wanted a season’s break to *“just enjoy my horses”* but was planning to come back in some way after that. However, she had enjoyed riding her horses with no pressure to compete so much that she was now not planning to rejoin Endurance GB again unless as an associate member to enable her to do pleasure rides but not competitive rides.

Interviewees two and three carried on their full membership throughout the pandemic period and were planning a full season in 2022 having re-joined as full members.

Interviewee two completed her first ride in early March 2022 and did not enjoy it, saying that it seemed a lot of trouble to get ready and compete and then be disappointed if the hoped-for grading did not materialize. Especially as her much-loved horse had tried so hard for her. So, it was better not to compete anymore and just spend as much time as possible riding her horse in a more relaxed way. She did say that she may change her mind later *“as I have spent so many years competing and have a young horse that is almost ready for competition”*. This interviewee has re-joined in mid-2023 after another year’s break.

Interviewee three had her “dream ride” planned for 2022 and was in full training but has simply decided that she does not want to compete any longer. She withdrew entries for planned rides and gave up competing but carried on with pleasure rides and supporting the sport, organizing her first ride in 2023.

The almost two-year break from competition was given as a reason by all three women for not carrying on. They had gotten out of the “habit” of training and competing and wanted just to enjoy riding their horses with no pressure. Interviewees two and three carried on their full membership for 2022 despite not riding and re-joined in 2023. Interviewee one was dissatisfied with Endurance GB when she decided not to re-join in 2020 and the competitive break has not changed her views.

Two other women in the author’s regional endurance group moved from full to supporter memberships to carry on with pleasure rides rather than competitive rides, also citing the break from competitive riding and training due to Covid as the driving force. These are also mature women who have been in the sport for many years.

The interviews were deliberately chosen from one regional group and the largest demographic in Endurance GB (mature women). Although the views are not generalizable, they indicate the mindset of long-term members and the impact that their decisions will have on a single regional group. In the interviewees’ case almost 17% of their regional group left.

### 3.6. Other Impacts Due to Covid

In addition to the findings from this research, according to Endurance GB's response to the British Equestrian Foundation (BEF)'s request for information on the impact of Covid on the sport, there have been negative impacts on the workforce, both volunteer and paid. Many of the volunteers (especially ride stewards) are mature, vulnerable to Covid, and uncomfortable about attending events even in the aftermath making some face-to-face events impossible to organize. However, those at events worked hard to ensure the safety of attendees from Covid. Further issues were the availability of vets and the ability of first aiders to renew their certificates.

The measures put in place around Covid security enabled Endurance GB to be one of the first equestrian disciplines to hold international competition in the UK under the extremely complex Digital, Culture, Media and Sport (DCMS) and FEI Elite Sport Covid Rules (according to Endurance GB's chairman).

During the 2023 season the impacts due to Covid lessened, with the volunteer workforce becoming more comfortable about supporting the sport on the ground at events. The rides still have security measures such as hand-sanitizer but the spectre of Covid has now largely disappeared (observational research from an EGB director).

## 4. Discussion

Undoubtedly Covid has had a negative effect on Endurance GB as it has for other sports worldwide (e.g. [Dashper & King, 2021](#); [Hughes et al., 2020](#)). Endurance is not just about the rider, but also the horse, who must be in the best condition and fitness levels and must be taken into consideration. In addition, there is the crew and as was seen from the data, this is usually a long-suffering partner or spouse, often with little interest in horses themselves (anecdotal/observational data). The entire team needs to be ready for an event and, the rider in particular, comfortable that fitness levels are what they need to be. Once there is a long break during the season and a drop in training levels, motivation appears to decrease, with the result that a small number of riders do not want to start training again. These are mainly older women who have already attained their goals within the sport. As the largest segment of Endurance GB members are mature women who have been members for several years, this finding could be the tip of the iceberg. As both survey and interview data confirmed this, more work needs to be done by Endurance GB to mitigate this attrition.

The ride entry trends show that although there was a large drop in entries in 2020 and 2021 due to Covid, these picked up almost to expected levels once rides appeared on the calendar again. This correlates with the survey findings of members re-joining in 2022 and the number of available rides in the calendar in 2022 and 2023. In the years leading to 2019, there were some international controversies causing a decline in membership (Endurance GB data) contrasting with statistics showing an upward trend in consumer spending on recreation and sport in the past 5 years or so ([Statista, 2022](#)). There is a potential for the ongoing negative change in weather conditions (particularly in the first part of the year) that impact ride entries. Riders are in training during the early part of the year after a short layoff after the previous season, and bad weather negatively affects this and therefore reduces entries for the early part of the season if horses are not riding fit in time. Therefore, climate change is adding to the decline of entries as we see weather patterns change and the ride season staying static.

Boden et al.'s (2013) discussion on distance travelled to rides correlates with the findings from this study. Riders are happy to regularly travel between 100 and 150 miles away (2–3 hours) in a day and compete ([Boden et al., 2013](#)). This tends to be for ride distances of 64K and below, with riders often staying overnight for longer rides to give their horses a rest from travelling before competing. Once the main issue of Covid was over, travel started to get back to normal.

The ability to ride during the Covid periods—both within lockdowns and other periods—was mixed amongst the membership. Many said that there was little or no change but the ability to travel horses to training grounds and visit livery stables undoubtedly impacted competition preparation for many. Add to this the riders themselves falling ill with Covid, worrying about doing so—or not wanting to ride in case of injury and putting strain on the NHS ([Ward et al., 2021](#)), and horse and rider fitness were often negatively impacted.

One of the main findings from this study is that there is an imbalance in demographics within the sport that is not Covid related. As with many equestrian sports, there is a large majority of females ([Wolframm & Meulenbroek, 2012](#)) and 80% are over the age of 45. This is a very imbalanced portfolio and, according to Endurance CB data, attrition rates of members rose in 2023 as the break in training caused by Covid has broken the “competing habit” for some—particularly those aged 55 and above. The doubling of junior members, albeit in low numbers, is encouraging but the drop in young riders (age 14 to 25) is a concern for the longer-term future of the sport. This relates to research across a variety of sports which shows that adolescents often drop out if they feel sport isn't enjoyable anymore or that there is too much training. For example, in the US there



is around a 35% annual dropout rate from all sports for teenagers (Crane & Temple, 2014). Although not the subject of this study, further research in this area on equestrian sport and in particular endurance would be beneficial for the longevity of the sport.

Applying Maslow's hierarchy of needs to the findings and discussion in Table 2 shows how during and immediately post Covid Self Actualisation and Self Esteem for endurance riders were non-existent and there were many negative implications and changes for the lower levels of the hierarchy. For people who are competitive, this arguably has contributed to them taking a break or giving up completely as they are not fulfilled in their sport as simply belonging to it does not allow satisfying behavior on their part.

**Table 2.** Maslow's Hierarchy of Needs applied to Endurance Riding in the Covid era. (Negatives in italics).

Maslow's Hierarchy of Needs Level	Pre-Covid and 2023	During Covid 2020/21	Post Covid 2021/22
<b>Self Actualisation</b>	Moving through levels. Achieving more than expected. Admiration of fellow members.	<i>No achievements as no competitions. Staying static. Horses losing fitness.</i>	<i>Re-consolidating position from before covid. Lack of achievement.</i>
<b>Self Esteem</b>	Completing events with good results. Horse staying fit. Enjoyment. Kudos. Friendships. Part of subculture. Correct clothing. Teamwork. Horse and rider partnership	<i>No competitions. Horses losing fitness.</i>	<i>Fewer rides and shorter distances as horses not fit.</i>
<b>Love and Belonging</b>	Risk assessments. First aid. Insurance. Horse vaccinations. Vetting. Correct clothing.	Keeping connections digitally. <i>Memberships lapsing. Horses not ridden so bonds lessened.</i>	Re-connecting with friends. <i>Fewer members re-joining.</i>
<b>Safety and Security</b>	Crew stops. Water and Food. Correct clothing. Travel to events and staying over.	<i>Lockdowns. Restricted riding. Protecting the NHS.</i>	Fitness of horse and rider improving. <i>High levels of Covid security. Fewer riding restrictions.</i>
<b>Physiological</b>		<i>Lockdowns. Difficulty buying food. Digital shopping for horse needs. No travel. Wellbeing lessening through no riding.</i>	<i>Travel starting, often long distances as fewer events. Clothing and feed/food purchases back to normal.</i>

Source: Author's own work.

The results show that during the 2023 season, things had returned to normal from the events, fitness, and travel side, even though memberships were still lower than expected. Indications show that this is in line with the overarching decline (see Figure 1) (Endurance GB membership data). Some lapsed members re-joined in 2023 (including 2 of the 3 interviewees) but not all.

The overall understanding gained from this research is that Covid has been an unplanned negative intervention for all types of sports and is likely to shape physical activity and pastimes for the foreseeable future (Teare & Taks, 2021). However, for Endurance GB, although Covid has had an adverse effect on membership and individual events in the short term, this is within the landscape of a gradual decline within equestrian sport (Jones, 2019). However, it now appears to be back on the declining track. This is different from other UK sports (predominantly "urban") where membership fell on average by 60% during Covid with an expectation of a long recovery period (Barret & Coleman, 2021).

Reliance on members aged 45 and over is not healthy for the long-term vision of the sport but is a typical trend over the life of Endurance GB (Endurance GB data). Member retention policies should be adopted along with marketing campaigns to recruit and retain younger members, but the "low-hanging fruit" is still the older demographic. It is likely that younger people get their self-esteem and self-actualisation from other areas in their lives, whereas the older demographic is in a more settled pattern and endurance is a way of keeping fit and active as well as achieving their riding goals.

The large increase in the cost of living/fuel from early 2022 is undoubtedly a factor in lower entry numbers per ride, contributing to the long-term decline. A focus on understanding ride entry trends for every ride (local, national, and FEI) in detail, is suggested. International rider issues (more aligned to Brexit and issues travelling horses abroad) need also to be considered.

Further concentration on the recruitment and retention of junior members through their young rider years is suggested for the Endurance GB marketing and membership teams to combat attrition at the younger end of the member age scale and give longer-term lifetime value to the organisation.

According to Figure 1, not only was there a drop in ride entrants due to Covid (2020 and 2021) but in 2017/18 there was a smaller drop which was the precursor to trend of decline of competitors at early rides (due to the international issues noted earlier). The gradual decline in riders entering Endurance GB rides (see Jones, 2019) may not be able to be reversed in the short to medium term. It is recommended that Endurance GB's marketing function factors this in when undertaking further research and developing member recruitment and retention campaigns.

The removal of Self Esteem and Self Actualisation levels (in Maslow's hierarchy of needs) during Covid, resulting in loss of members should give Endurance GB a focus for design and construction of events. What do each level of members need to attain these levels and how can Endurance GB deliver on this even in times of unforeseen disruptions?

## 5. Conclusion

This study focused on the effect of Covid on endurance in the UK, and the findings have shown that the negative impact was short-term. More concerningly for the governing body (Endurance GB) is the long-term slow decline in ride entries and membership, which (apart from the change from members to supporters in 2021/2022) cannot be attributable to the pandemic. As can be seen from the section above, further research needs to be undertaken to understand this decline.

Have we, as a population, become so far removed from lower levels of Maslow's Hierarchy of Needs that our Physiological and Safety/Security levels are taken for granted until there is a large-scale disruption such as the Covid pandemic or large-scale conflict? And do we now focus on the Love and Belonging level as the basis of our lives, moving into Self Esteem and Self Actualisation as an acceptance rather than aspiration?

The evidence supplied from this research has posed new questions but will allow more detailed enquiry from further studies in the area.

**CRedit Author Statement:** This is a single author paper and the author was solely responsible for the content, including the concept, design, analysis, writing, and revision of the manuscript.

**Data Availability Statement:** The data used in the study is held by the author or by Endurance GB.

**Funding: Please add:** This research received no external funding.

**Conflicts of Interest:** The author declares no conflict of interest.

**Acknowledgements:** Thanks to all research participants and EGB for the use of their data.

## References

- Barrett, D., & Coleman, R. (2021). Returning to Action: Evaluating Organisational Preparedness in the Wake of the Covid-19 Pandemic. *Sport+ Recreation Alliance, Sheffield Hallam University*.  
<https://sramedia.s3.amazonaws.com/media/documents/88a4060a-00cc-4ccc-89e7-1dbf9f910cd5.pdf>
- Boden, L. A., Parkin, T. D., Yates, J., Mellor, D., & Kao, R. R. (2013). An online survey of horse-owners in Great Britain. *BMC Veterinary Research, 9*. <https://doi.org/10.1186/1746-6148-9-188>
- Crane, J., & Temple, V. (2014). A systematic review of dropout from organized sport among children and youth. *European Physical Education Review, 21*(1), 114–131. <https://doi.org/10.1177/1356336X14555294>
- Dashper, K., & King, J. (2021). The outdoors and contested leisure terrain. *Annals of Leisure Research, 25*(3), 435–443.  
<https://doi.org/10.1080/11745398.2021.1899832>
- DiFiori, J. P., Green, G., Meeuwisse, W., Putikian, M., Soloman, G. S., & Sills, A. (2021). Return to sport for North American professional sport leagues in the context of COVID-19. *British Journal of Sports Medicine, 55*(8), 417–421.  
<https://doi.org/10.1136/bjsports-2020-103227>
- Fleming, P., Paisley, C., Barnes, A., & Wemelsfelder, F. (2013). Application of Qualitative Behavioural Assessment to horses during and endurance ride. *Applied Animal Behaviour Science, 144*(1–2), 80–88. <https://doi.org/10.1016/j.applanim.2012.12.001>
- Grix, J., Brannagan, P. M., Grimes, H., & Neville, R. (2020). The impact of Covid-19 on sport. *International Journal of Sport Policy and Politics, 13*(1), 1–12. <https://doi.org/10.1080/19406940.2020.1851285>
- Hughes, D., Saw, R., Perera, N., Mooney, M., Walleit, A., Cooke, J., Coatsworth, N., & Broderick, C. (2020). The Australian Institute of Sport framework for rebooting sport in a COVID-19 environment. *Journal of Science and Medicine in Sport, 23*(7), 639–663.  
<https://doi.org/10.1016/j.jsams.2020.05.004>
- Jones, E. (2019, June 26). *Number of riders is up but horse numbers drop, major survey reveals*. Horse and Hound.  
<https://www.horseandhound.co.uk/news/number-uk-riders-horse-numbers-drop-major-survey-reveals-690369>

- Maditinos, Z., Vassiliadis, C., Tzavlopoulos, Y., & Vassiliadis, S. A. (2021). Sports events and the Covid-19 pandemic: Assessing runners' intentions for future participation in running events—evidence from Greece. *Tourism Recreation Research*, 46(2), 276–287. <https://doi.org/10.1080/02508281.2020.1847422>
- Maslow, A. H. (1968). *Toward a psychology of being* (2<sup>nd</sup> Ed). New York, Van Nostrand.
- McDonald, M. A., Milne, G. R., & Hong, J. B. (2002). Motivational factors for evaluating sport spectator and participant markets. *Sport Marketing Quarterly*, 11(2), 100–113.
- Phillipson, J., Gorton, M., Turner, R., Shucksmith, M., Aitken-Dermott, K., Areal, F., Cowie, P., Hubbard, C., Maioli, S., McAreavey, R., Souza-Monteiro, D., Newbery, R., Panzone, L., Rowe, F., & Shortall, S. (2020). The Covid-19 Pandemic and its implications for rural economies. *Sustainability*, 12(10), 3973. <https://doi.org/10.3390/su12103973>
- Skinner, J., & Smith, A. C. T. (2021). Introduction: Sport and COVID-19: Impacts and challenges for the future (Volume 1). *European Sport Management Quarterly*, 21(3), 323–332 <https://doi.org/10.1080/16184742.2021.1925725>
- Staley, K., Randle, E., Donaldson, A., Seal, E., Burnett, D., Thorn, L., Forsdike, K., & Nicolson, M. (2021). Returning to sport after a Covid-19 shutdown: Understanding the challenges facing community sport clubs. *Managing Sport and Leisure*, 29(1), 107–127. <https://doi.org/10.1080/23750472.2021.1991440>
- Statista. (2023). *Expenditure on sporting services and recreation in the UK 2005–2022*. <https://www.statista.com/statistics/429762/consumer-spending-on-sports-and-recreation-in-the-united-kingdom-uk/>
- Stowe, A., Upshaw, K., Estep, C., & Lanzi, R. G. (2022). Getting to the sandbar: Understanding the emotional phases of COVID-19 among college and university students. *Psychological Reports*, 125(6), 2956–2980 <https://doi.org/10.1177/00332941211028105>
- Teare, G., & Taks, M. (2021). Exploring the impact of the COVID-19 pandemic on youth sport and physical activity participation trends. *Sustainability*, 13(4), 1744. <https://doi.org/10.3390/su13041744>
- Valev, Y. (2015). Planning the one year training process in equestrian sport endurance discipline. *Activities in Physical Education and Sport*, 5(2), 256–260.
- Ward, A., Stephen, K., Argo, C., Watson, C., Harris, P., Neacsu, M., Russell, W., Grove-White, D., & Morrison, P. (2021). The human aspect of horse care: How the COVID-19 pandemic impacted the wellbeing of equestrian industry stakeholders. *Animals*, 11(8), 2163 <https://doi.org/10.3390/ani11082163>
- Wolframm, I. A. & Meulenbroek, R. G. J. (2012). Co-variations between perceived personality traits and quality of interaction between female riders and horses. *Applied Animal Behaviour Science*, 139(1–2), 96–104. <https://doi.org/10.1016/j.applanim.2012.03.006>

## Article

# Credit Risk Game Analysis and Control Model of RMSEs—Based on the Perspective of Green Credit

Xi Zhou <sup>1</sup>, Chuang Yang <sup>2</sup>, Caiyu Wan <sup>1,\*</sup>, Wei Gao <sup>3</sup>, Suping Ye <sup>4</sup>, Lingyan Wu <sup>4</sup>, and Luyao Liu <sup>1,\*</sup>

<sup>1</sup> Jiyang College, Zhejiang A&F University, Zhuji 311800, China; [zhouxi654321@126.com](mailto:zhouxi654321@126.com) (X.Z.); [wandawan888@gmail.com](mailto:wandawan888@gmail.com) (C.W.); [liuluyao2019@163.com](mailto:liuluyao2019@163.com) (L.L.)

<sup>2</sup> School of Economics and Management, Zhejiang A&F University, Hangzhou 311300, China; [18968150852@163.com](mailto:18968150852@163.com)

<sup>3</sup> International Exchange College, Hankou University, Wuhan 430212, China; [hkxygj\\_edu@sina.com](mailto:hkxygj_edu@sina.com) (W.G.)

<sup>4</sup> Jiande Bureau of Agriculture and Rural Affairs, Jiande 311699, China; [13516878581@163.com](mailto:13516878581@163.com) (S.Y.); [13867459380@163.com](mailto:13867459380@163.com) (L.W.)

\* Correspondence: [wandawan888@gmail.com](mailto:wandawan888@gmail.com) (C.W.); [liuluyao2019@163.com](mailto:liuluyao2019@163.com) (L.L.)

**Abstract:** RMSEs (rural micro and small enterprises) absorb the rural surplus labor force for employment and entrepreneurship, which is an important economic growth point in rural areas in the future. However, RMSEs have narrow financing channels and difficult financing problems, which hinder the development of the rural economy. If RMSEs want to develop sustainably, they need to find effective financing channels. RMSEs no longer use traditional means of financing through commercial bank loans but are looking for newer financing modes, such as online loan platforms, investors, and so on. This paper takes RMSEs as the main body, RMSEs target rural commercial banks, online loans, and investors as funding instruments, and through building a benchmark model of the evolution game between funding instruments and RMSEs, banks, based on the perspective of green credit other investors industry competition and market regulatory mechanisms and to build a control model of credit risk of RMSEs to reduce the credit risk of RMSEs.

**Citation:** Zhou, X.; Yang, C.; Wan, C.; Gao, W.; Ye, S.; Wu, L.; Liu, L.

Credit Risk Game Analysis and Control Model of Rural Small and Micro Enterprises—Based on the Perspective of Green Credit. *Agricultural & Rural Studies*, 2024, 2, 2.

<https://doi.org/10.59978/ar02020012>

Received: 15 January, 2024

Revised: 17 March, 2024

Accepted: 17 May, 2024

Published: 5 June, 2024

**Publisher's Note:** SCC Press stays neutral with regard to jurisdictional claims in published maps and institutional affiliations.



**Copyright:** © 2024 by the author(s). Licensee SCC Press, Kowloon, Hong Kong S.A.R., China. The article is an open access article distributed under the terms and conditions of the Creative Commons Attribution (CC BY) license (<https://creativecommons.org/licenses/by/4.0/>).

**Keywords:** RMSEs; game theory; credit risk; green credit

## 1. Introduction

Against the backdrop of China's vigorous promotion of its rural revitalization strategy, RMSEs, as an essential part of rural economic development, are the backbone of the rapid development of the rural economy. China's rural areas have a large number of microenterprises, which have made significant contributions to rural employment and economic growth, but RMSEs still suffer from many problems in the process of development, such as small scale of enterprises, poor operating capacity, etc., due to the lack of a complete and convincing credit record, insufficient property mortgage strength, opaque finances, and high loan operation costs of financial institutions make RMSEs difficult and expensive to obtain financing. These problems have also become bottlenecks, restricting their development and growth. How to ensure the healthy development of RMSEs has a bearing not only on the structure of the main body of enterprises in the socialist market economy but also on the rate of economic growth in China. At present, the results of China's latest national economic census show that the overall number of RMSEs in China has continued to increase, the business market has been improving, and the enterprise industry chain is more widely distributed. RMSEs have become an important and indispensable part of China's overall socio-economic market development. China's small and micro-enterprises ensure their own survival or development. However, in the process of development, the phenomenon of rural small and micro-enterprises cannot be collected at the end of the financing of the phenomenon of loans. In green finance credit support for micro and small enterprises, there have also been various credit "crises". As more than 70 percent of urban residents and more than 80 percent of rural residents in the national employment market rely on RMSEs for their survival, once a credit "crisis" occurs in RMSEs' financing and lending, not only will third-party investors suffer losses, but it will also result in turbulence in the development of the market economy and an increase in the pressure on employment.

microenterprises is on an upward trend, its employment at the end of the year. The number of people has shown a decreasing trend in recent years. With the use of statistics and mathematics found in the assessment of credit risk in RMSEs, domestic and foreign research scholars use the method of accurate measurement and prediction (Boushnak et al., 2018). Credit risk, which is the risk that the counterparty will not honor its obligations as they fall due. The expert scoring method is the earliest method to quantitatively analyze the credit risk of RMSEs. Scholar Thomas proposed the “5C method”, which is the most commonly used expert scoring method (Breedem, 2021). In recent years, under the impact of various environments, foreign research on RMSEs has been different from Berger and Black, who pointed out through research that the current behavior of larger banks in the United States is to increase financing investment for RMSEs (Mhlanga, 2021). Since 2019, foreign scientists from Evita Hayatun Nufus have begun to focus on the analysis of the credit risk of rural micro- and small enterprises in the environmental impact of COVID-19 (Blanco-Oliver et al., 2021).

With the growth of the Internet, the RMSEs develop rapidly, resulting in the development of a series of problems at the same time, attracting a number of Chinese scholars to pursue successive research. RMSEs are also involved in the development of the financing process, China has a characteristic urban and rural structural system for scholars to bring innovation in the direction of research (Nufus et al., 2021). Peng Lu (2018) used an improved BP neural network approach to model the credit risk of rural microenterprise business financing (Peng, 2018). Tan Xiaofen & Zhang Hui (2018) studied the credit analysis of RMSEs based on the improved GSO (Generic Segmentation Offload) and ELM (Extreme Learning Machines) integrated algorithm (Tan & Zhang, 2018). Zhu et al. (2019) studied the error back-propagation (BP) establishment (SME), which is mainly used in connection with the supply chain management budget model, which is used to discuss the major factors affecting micro and small enterprise financing as well as the benefits of supply chain budgeting (Zhu et al., 2019). Solving the expense problem of small and medium enterprises and the support vector machine is mainly based on solving major credit risks such as poor information transparency in small and medium-sized enterprises (Shi et al., 2019). In their research on the credit risk of RMSEs, taking rural areas as an example, Kuang et al. (2020) used the logic model to focus on the analysis of rural microenterprises, which is significant to improving the strength of rural microenterprises (Kuang et al., 2020). Abdel-Basset et al. (2020) made an empirical analysis of RMSEs (textile industry), using metrics, prediction methods, and a logistics model to build a supply chain finance for the credit risk of rural enterprises (Abdel-Basset et al. 2020). RMSEs credit risk credit status and corresponding supply chain combined. Yang et al. (2021) built a vector machine model and analyzed the unique real estate enterprises in the supply chain to verify the credit risk of RMSEs (Yang et al., 2021).

In general, relevant scholars currently use a variety of methods to analyze the credit risk game of RMSEs, which has opened up fields and circles for the research of RMSEs. The types of credit risk can be divided into Counterpart Default, Probability of Default (PD), Loss Severity (LR, Loss Rate, RR, Recovery Rate, Exposure Risk (EAD, Exposure At Default), and Settlement Risk. Specifically, existing research results provide a better foundation for this study. In terms of credit risk evaluation system, supply chain, financing banks, and other aspects, the credit status and financing status of rural microenterprises are studied. Supply chain, financing banks, etc., to study the credit status and financing status of small and micro enterprises in rural areas (Fang, 2022; He & Hu, 2018). Advantages of the current research on RMSEs: avant-garde vision, novel ideas, deep theoretical research, advanced technology. But its disadvantages are the integration of the general environment, cross-border thinking, which is more difficult in practice, and the use of technology, which is easy to involve in enterprise privacy issues. Both domestic and foreign countries have improved the research technology of RMSEs, innovated new data models, and proposed relevant decisions, but they have not proposed relevant post-control plans (Pratama et al., 2016; Serrano-Cinca et al., 2016; Shi et al., 2016; Wang et al., 2016). On research methods, it is the combination of support neural network and supply chain finance, constructing models, adopting quantitative analysis, GSO and ELM integration algorithms, based on blockchain technology, and so on. It can be found through the literature study that only a small number of scholars studied the plight of RMSE combined with the current global economic situation and the environment of the post-epidemic era in decision-making analyses. However, there are relatively few studies on the supply chain credit risk of rural small and micro-enterprise retailers (Jones et al., 2015; Li et al., 2018; Meng & Chi, 2015).

This paper proceeds from the research idea of “questioning—analyzing—solving”. This study uses a variety of methods, including literature research, a questionnaire survey, which is commonly used, tripartite evolutionary game theory, and Python model verification (Gray & Rumpe, 2017; Singh & Hess, 2020). This study explores the game analysis of credit risk in the government and banks RMSEs with micro and small enterprises under the perspective of green credit. Green credit is often referred to as sustainable finance or environmental finance. The purpose of this paper is to analyze the game between sustainable supply chain retailers RMSE and commercial banks in the

post-epidemic environment. Starting from the target object, this study explores the credit status of small and medium-sized enterprises (SMEs), conducts a game analysis relying on the SFC (Space Filling Curve) of data credit, proposes an analysis of the credit risk of RMSEs which is targeted at rural micro-enterprises. Then, this study uses the logistic regression method to find out the credit risk control factors affecting RMSEs, so as to build a control model. Finally, this study proposes an adjusted decision-making plan for the control factors from the appropriate perspective (Kotarba, 2016).

## 2. Materials and Methods

Through the analysis of all kinds of related literature, it was found that the use of classical game theory and its proposed assumptions relative to the evolution of game theory, in the “complete” logic, which does not show a good equilibrium dynamic game, can’t be more rationalized to highlight the changes in the form of the social market economy, therefore, to better evolve the law of change. The evolutionary dynamic mechanism of differential equations was proposed by Taylor and Jonker in 1978. This paper constructs an evolutionary game model, which is based on a set of differential equations, among RMSEs, third-party investors, and government regulators. This paper mainly explores that RMSEs can be third-party investor participation and government regulation of RMSEs. Three-party investors mainly for RMSEs through capital financing, borrowing, loans, etc. for RMSEs to provide paid capital transactions, such as banks, investors, and other borrowers. Government regulators can mainly realize the regulation of RMSEs and third-party investor regulators.

Compared with previous research scholars, this paper focuses on as following. Firstly, in order to make a discussion of the three-party in the evolutionary game theory, this study analyzes the strategy of the stability of the game point. This paper first introduced the government regulation as well as the profile of the third-party investor and the credit risk of RMSEs and the third-party investor between the existence of the investment behavior. Secondly, Lyapunov The first method analyzes the stability of the assumptions, pure strategy replication dynamic system, and equilibrium point of the mixed strategy, to obtain the conclusion of the evolution of the stable strategy combination under different conditions. Thirdly, this study uses Python to analyze the control model for the different initial conditions, and conclusions verification. Finally, this study gives corresponding recommendations.

The production capacity and risk-bearing capacity of RMSEs play a decisive role in the credit risk of RMSEs. This paper constructs an evolutionary game model among RMSEs, third-party investors, and government regulators, as shown in Figure 1.

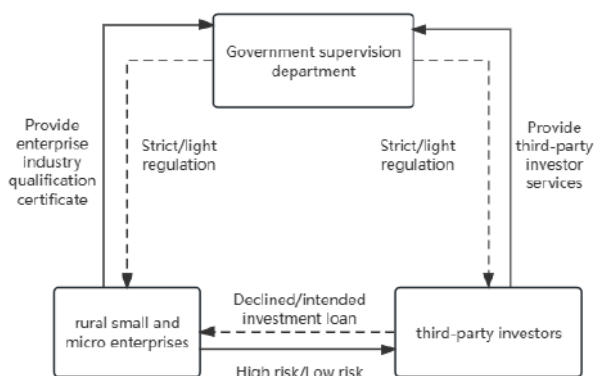

**Figure 1.** A three-party credit risk progression diagram using game theory in rural small and micro companies.

### 2.1. Basic Assumptions

Based on the online questionnaire data, it is discovered that in order to construct the tripartite evolutionary game model, care must be taken to guarantee that the parties’ decisions are stable, and that the equilibrium point reaches stability in the face of a changing decision-making environment. The ensuing presumptions are made in light of each factor.

#### (1) Hypothesis 1

The evolutionary game model includes three subjects, such as RMSEs, third-party investors (banks, investors, other investors), and government regulators, naming three subjects as participants 1, 2, and 3, respectively. The optimal strategy stability points in the three evolved strategies evolve over time.

## (2) Hypothesis 2

Low credit risk for MSMEs represents a high repayment capacity and low-risk index in green credits, in contrast to high credit risk for MSMEs, which represents a weak repayment capacity and a high-risk index. The strategic space of RMSEs  $\alpha = (\alpha_1, \alpha_2) = (\text{low credit risk, high credit risk})$ , and is selected with probability  $x$ ,  $\alpha_1$ ,  $(1-x)$  choose with probability  $\alpha_2$ ,  $x \in [0, 1]$ ; The strategy space of the third-party investor is  $\beta = (\beta_1, \beta_2) = (\text{rejection of investment, intention to invest})$ , its selection  $\beta_1$  probability is  $y$ , and the selection  $\beta_2$  probability is  $(1-y)$ ,  $y \in [0, 1]$ ; The strategy space of the government regulatory department  $\gamma = (\gamma_1, \gamma_2) = (\text{strict regulation, lax regulation})$ , and is selected with probability  $z$ ,  $\gamma_1$ ,  $(1-z)$  selected with probability  $\gamma_2$ ,  $z \in [0, 1]$ .

## (3) Hypothesis 3

The income of small and micro enterprises in rural areas is  $R_p$ , the cost of rural microenterprises with high credit risk is  $C_{ph}$ , and the cost of rural microenterprises with low credit risk is  $C_{pl}$ ,  $C_{ph} > C_{pl}$ . When RMSEs produce products, government departments regulate them, and the products are tested and qualified. When RMSEs have high credit risk, they will seek investment from third-party investors to obtain more funds, and the cost of seeking investment is  $B$ ,  $B < C_{ph} - C_{pl}$ . The speculative costs incurred will be for the speculative behavior of the products produced by RMSEs, where the main business management costs are falsification of production records and false and illegal publicity, etc., and let the speculative costs of RMSEs be  $C_p$ .

## (4) Hypothesis 4

RMSEs can have more liquidity through the funding of third-party investors, and the third-party investor will also receive a return on the investment return of  $V_t$ . When the credit risk of RMSEs is high, if the third-party investor has an intention to "refuse to invest", the financing will fail. If the investor "intends to invest", the two-party will engage in investment behavior. Investors can help RMSEs with low credit risk to access capital, and then RMSEs are successful in financing. The speculative cost of a third-party investor's intended investment is  $C_t$ , which includes the cost of advancing rural MSME funding gaps and enhancing information security.

## (5) Hypothesis 5

When the pressure of government regulation is very high, if RMSEs are at high credit risk, they will be fined  $F_p$  by the government regulator, and third-party investors who have taken the intention to invest in rural microenterprises will be fined  $F_t$  accordingly. RMSEs are rewarded  $M_p$  if they are at low credit risk and  $M_t$  is given to third-party investors who refuse to invest. If the government regulator, loosens or deregulation, because there is no decision-making data for both rural microenterprises and investors, for this reason, the government regulator is unable to judge and exercise the responsibility of rewards and punishments, set  $C_g$  be the cost of strict government regulation.

## (6) Hypothesis 6

In rural areas, small and micro enterprises with low credit risk are conducive to economic development and social stability and will have a corresponding social benefit value  $A_g$  to society and government. When RMSEs are at high credit risk and have reached an agreement with a third-party investor to invest, high credit risk RMSEs financing enters the market, which affects employment stability and economic development, and costs the government the cost of maintaining social stability and regulating RMSEs  $D_g$ . Government regulators adopt a lax regulatory strategy, resulting in inadequate supervision, and high credit risk. RMSEs financing into the market situation, the higher-level regulators will be the lower level of the exercise of responsibility of the government regulators on the corresponding punishment, set  $T_g$  is the amount of administrative penalties of the higher level,  $T_g > C_g$ .

## 2.2. Model Parameter Setting

Based on the above assumptions, the mixed strategy game matrix among rural small and micro enterprises, third-party investors, and government regulators is shown in Table 1.

**Table 1.** Three-way mixed-strategy game matrix.

investor		Regulatory authorities		
		z keep under strict supervision	1 - z Lax regulation	
RMSEs	Low credit risk x	refuse to invest y	$R_p - C_{ph} + M_p, V_t + M_t - C_g - M_p - M_t$	$R_p - C_{ph}, V_t, A_g$
		Intentional investment 1 - y	$R_p - C_{ph} + M_p, V_t - C_t - F_t - C_g - M_p$ $+ A_g$	$R_p - C_{ph}, V_t - C_t, A_g$
	High credit risk 1 - x	refuse to invest y	$-C_{ph} - C_p - F_p, V_t + M_t - C_g + F_p - M_t$	$-C_{ph} - C_p, V_t, 0$
		Intentional investment 1 - y	$R_p - C_{ph} - C_p - B_t - F_p, V_t - C_t + B_t$ $- F_t - C_g + F_p + F_t$ $- D_g$	$R_p - C_{ph} - C_p - B_t, V_t - C_t$ $+ B_t, -D_g$ $- T_g$

2.3. Model Analysis

(1) Analysis of the stability of rural small and micro enterprise strategies

( $E_{11}, E_{12}, \bar{E}_1$ ) represents the expected return for RMSEs with high credit risk, the expected return with low credit risk, and the average expected return, respectively, relative to:

$$\begin{cases} E_{11} = yz[R_p - C_{ph} + M_p] + y(1 - z)[R_p - C_{ph}] + (1 - y)z[R_p - C_{ph} + M_p] + (1 - y)(1 - z)[R_p - C_{ph}] \\ E_{12} = z[(1 - y)(R_p - B_t) - C_{pl} - C_p - F_p] + (1 - z)[(1 - y)(R_p - B_t) - C_{ph} + C_p] \\ \bar{E}_1 = xE_{11} + (1 - x)E_{12} \end{cases} \quad (1)$$

Replicating dynamic equations:

$$\begin{aligned} F(x) &= dx/dt \\ &= x(xE_{11} - \bar{E}_1) \\ &= x(x - 1)[C_{ph} - C_{pl} - C_p - B_t - y(R_p - B_t) - z(F_p + M_p)] \end{aligned} \quad (2)$$

The first-order derivatives of X and the set G(y) are respectively:

$$\frac{d(F(x))}{dx} = (2x - 1)C_{ph} - C_{pl} - C_p - B_t - y(R_p - B_t) - z(F_p + M_p) \quad (3)$$

$$G(y) = C_{ph} - C_{pl} - C_p - B_t - y((R_p - B_t) - z(F_p + M_p)) \quad (4)$$

According to the law of stability of differential equations, rural MSMEs are in a steady state for low credit risk must satisfy:  $F(x) = 0$  and  $dF(x)/dx < 0$ . Since  $\partial G(y) / \partial y < 0$ ,  $G(y)$  is a decreasing function with respect to  $y$ . Therefore: at that time,  $y = [C_{ph} - C_{pl} - C_p - B_t - z(F_p + M_p)] / (R_p - B_t) = y^*G(y) = 0$ ,  $dF(x)/dx = 0$ , this is an uncertain strategy; at that time,  $y < y^*G(y) > 0$ , at this time  $dF(x) / dx|_{x=0} < 0$ ,  $x = 0$  is the evolutionary stable strategy of (ESS) RMSEs; conversely,  $x = 1$  is ESS. The strategy evolution phase of RMSEs Figure, as shown in Figure 2.

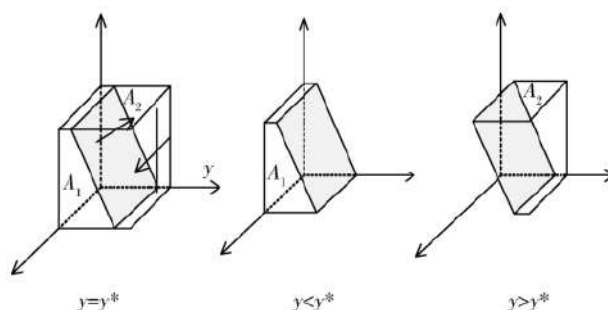

**Figure 2.** Phase diagram of strategic evolution of RMSEs.

The above figure shows that the probability of a RMSEs being at a stable low credit risk is calculated as the volume  $A_1$  of  $V_{A1}$ , the probability of being at a stable low credit risk is calculated as the volume  $A_2$  of  $V_{A2}$ :

$$V_{A1} \int_0^1 \int_0^1 \frac{C_{ph} - C_{pl} - C_p - B_t - z(F_p + M_p)}{(R_p - B_t)} dz dx$$



$$= \frac{2(C_{ph} - C_{pl} - C_p - B_t) - (F_p + M_p)}{2(R_p - B_t)} \quad (5)$$

$$V_{A2} = 1 - V_{A1}$$

Corollary 1: The probability of a RMSEs being in a low credit risk state is positively related to the RMSEs’ production and marketing revenues, investment costs, speculative costs, and government incentives and penalties, and is negatively related to the costs saved by the RMSEs’ high credit risk.

Proof: Based on the expression for the probability of a RMSEs being a low credit risk,  $V_{A2}$ , the first-order partial derivatives of each element are obtained as: find the first-order partial derivatives of each factor, we get:  $\partial V_{A2} / \partial R_p > 0$ ,  $\partial V_{A2} / \partial (F_p + M_p) > 0$ ,  $\partial V_{A2} / \partial C_p > 0$ ,  $\partial V_{A2} / \partial (C_{ph} - C_{pl}) < 0$ , therefore, an increase in  $R_p$ ,  $B_t$ ,  $(F_p + M_p)$  or a decrease in  $C_{ph} - C_{pl}$  will increase the probability of a RMSEs being at low credit risk.

Corollary 1 shows that safeguarding the income from production and sales of RMSEs can prevent them from being exposed to high credit risk. The government can improve the strength of rewards and penalties in the exercise of supervision, which will effectively reduce the probability of high credit risk for small and micro enterprises in rural areas and can also use high-tech means to increase the speculative costs of RMSEs with the help of external forces, which will be conducive to the reduction of credit risk for rural microenterprises.

Corollary 2: The probability of low credit risk for rural microenterprises increases as the probability that the game generates investor “refusals” and strict regulation increases.

Proof: In the analysis of the decision-making of RMSEs,  $z < [C_{ph} - C_{pl} - C_p - B_t - y(R_p - B_t)] / (F_p + M_p)$ ,  $y < y^*$  when,  $\bar{G}(y) > 0$ ,  $\bar{d}(\bar{F}(x)) / \bar{d}x|_{x=0} < 0$ , then  $x=0$  is an evolutionary strategy; conversely,  $x=1$  is an evolutionary strategy. Thus, as  $y, z$  gradually increase, the stabilisation strategy for RMSEs increases from  $x = 0$  (Low credit risk) to  $x = 1$  (high credit risk).

Corollary 2 indicates that increasing the likelihood of refusal to invest generated by third party investors will contribute to the reduction of credit risk in RMSEs, making it low credit risk as an accurate decision. Increasing the probability of strict supervision by government regulators can effectively ensure the credit risk of rural microenterprises. Or ensuring the rigor of third-party investors, such as the third-party investor’s own sense of responsibility, social responsibility, external assistance, etc. can effectively ensure that the rural microenterprise’s credit supervision, to achieve the credit risk of rural microenterprises, the social management of the atmosphere of the co-management.

(2) Strategic stability analysis of third-party investors

The expected return  $E_{21}, E_{22}, \bar{E}_2$  of the third-party investor who chooses to decline to invest and intends to invest is the average expectation:

$$\begin{cases} E_{21} = x[z(V_t + M_p) + (1 - z)V_t] + (1 - x)[z(V_t + M_t) + (1 - z)V_t] \\ E_{21} = x[z(V_t - C_t - F_t) + (1 - z)(V_t - C_t)] + (1 - x)[V_t - C_t + B_t - zF_t] \\ \bar{E}_2 = yE_{21} + (1 - y)E_{22} \end{cases} \quad (6)$$

Replicating the dynamic equations and the corresponding first-order derivatives from (6):

$$F(y) = dy/dt = y(xE_{21} - \bar{E}_2) = y(y - 1)[(1 - x)(B_t - M_t) - z(F_p + M_t) - C_t] \quad (7)$$

$$\frac{d(F(y))}{dy} = (2y - 1) [(1 - x)B_t - z(F_p + M_t) - C_t] \quad (8)$$

$$\text{Set } J(z) = (1 - x)B_t - z(F_p + M_t) - C_t \quad (9)$$

Based on the stability of the differential equation, it is known that to stabilize the probability of a third-party investor rejecting an investor, it is necessary to achieve:  $F(y)=0$  and  $dF((y))/dy<0$ . Since  $J(z)$  is negatively correlated. Therefore: at that time,  $z = (1 - x)B_t - \frac{C_t}{(F_t + M_t)} = z^*$ ,  $J(z) = 0$ ,  $dF((y)) / dy = 0$ ,  $F(y) = 0$ , the third-party investor cannot determine the stable strategy; at that time,  $z < z^*$ ,  $J(z) > 0$ ,  $dF((y)) / dy|_{y=0}<0$ , it is  $y=0$ ESS; at that time,  $z > z^*$ ,  $J(z) < 0$ , it is  $y=1$  ESS. The evolution phase diagram of third-party investor strategies is shown in Figure 3.

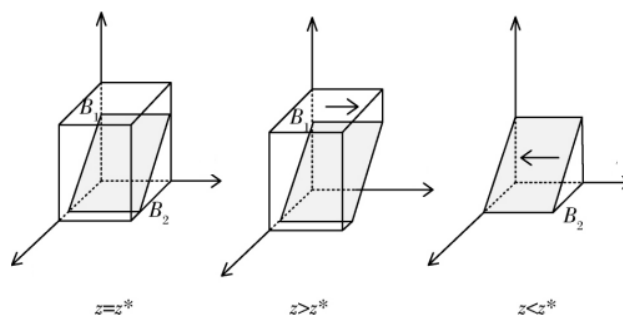

Figure 3. Third-party investor strategy evolution phase diagram.

From Figure 3, the volume  $C_1$  of  $V_{C_1}$  represents the probability of strict regulation by the government regulator, and the volume  $C_2$  of  $V_{C_2}$  represents the probability of lax regulation. As follows:

$$\begin{aligned}
 V_{C_1} &= \int_0^1 \int_0^1 \frac{F_p + F_t + T_g - C_g - x(M_p + F_p + T_g)}{(F_t + M_t + T_g - xT_g)} dx dy \\
 &= \frac{M_p + F_p + T_g}{T_g} - \left[ \frac{M_p + F_p + C_g}{T_g} + \frac{(M_p + F_p)(M_t + F_t)}{T_g^2} \right] \ln \left( 1 + \frac{T_g}{M_t + F_t} \right) \\
 V_{C_2} &= \left[ \frac{M_p + M_t + C_g}{T_g} + \frac{(M_p + F_p)(M_t + F_t)}{T_g^2} \right] \ln \left( 1 + \frac{T_g}{M_t + F_t} \right) - \frac{M_p + F_p}{T_g}
 \end{aligned} \tag{10}$$

Corollary 3: Fines for rural MSEs and administrative fines for lower-level regulators will be an additive function of strict government regulation, while fines for third-party investors and rural MSEs will be a subtractive function of strict regulation, and fines for third-party investors will be a function of a large number of factors that cannot be determined.

Proof: The first-order partial derivatives of each of the elements are obtained separately for  $\partial V_{B_1} / \partial B_t < 0$ ,  $\partial V_{B_1} / \partial M_t > 0$ ,  $\partial V_{B_1} / \partial F_t > 0$ ,  $\partial V_{B_1} / \partial C_t > 0$ . Thus, a decrease in  $B_t$  and an increase in  $M_t$ ,  $F_t$  and  $C_t$  increase the probability that a third-party investor will refuse to invest.

Corollary 3 suggests that when third-party investors earn a large return on their investments, the government should strengthen strict regulation of third-party investors. In addition, by improving the professionalism of investors and expanding the media’s disclosure efforts, the speculative costs of third-party investors’ investments can be increased, and their speculative behaviors can be reduced in the interest of the third-party investors. Severe penalties can effectively protect the capital recovery of third-party investors, as well as the credit risk of RMSEs, and can also take incentives to help their financing.

Corollary 4: During the game, as the probability of strict government regulation increases, it increases the probability of speculative behavior by third-party investors who refuse to invest.

Proof: on the basis of the stability of third-party investors’ decisions,  $y = 0$  is ESS when  $z < z^*$ ,  $x < B_t - M_t - C_t - z(F_t + M_t) / (B_t - M_t) = x^*$ ,  $y = 0$ ;  $z > z^*$ ,  $x > x^*$ ;  $y = 1$  is ESS when  $z > z^*$ ,  $x > x^*$ . Therefore, when  $x$ ,  $z$  becomes bigger and bigger and  $y = 0$  appears when the third party investor refuses to invest up to  $y = 1$ , then  $x$ ,  $z$ , and  $y$  are positively correlated.

Corollary 4 suggests that the decision-making behavior of third-party investors will be influenced by rural MSMEs and government regulators. The government to increase strict supervision, RMSEs to reduce credit risk for low credit risk probability can promote third-party investors to refuse to invest as a stable strategy. For this reason, the strict supervision of government regulators, in favor of rural small and micro-enterprise industry economic development, to protect the interests of third parties, to protect the normal operation of RMSEs, incentives for RMSEs in the mode of production and operation, the introduction of corresponding policies and other measures.

(3) Analysis of the stability of government regulators’ strategies  $E_{31}$ ,  $E_{32}$ ,  $\bar{E}_3$ , are the expected returns to strict regulation, the expected returns to lax regulation, and the expected returns to average regulation by government regulators, respectively:

$$\begin{cases}
 E_{31} = -C_g + xA_g - xM_p - yM_t + (1-x)F_p + (1-y)F_t - (1-x)(1-y)D_g \\
 E_{32} = xA_g - (1-x)[0 + (1-y)(D_g - T_g)] \\
 \bar{E}_3 = zE_{31} + (1-z)E_{32}
 \end{cases} \tag{11}$$

(9) is the replicated dynamic equation for the regulator, (12) is the first order derivative, and (13) is the hypothetical  $H(y)$ :

$$F(z) = dz/dt = z(z - 1)[C_g - F_p - F_t - T_g + x(M_p + F_p + T_g) + y(M_t + F_t + T_g) - xyT_g] \tag{12}$$

$$d(F(z))/dz = (2z - 1)[C_g - F_p - F_t - T_g + x(M_p + F_p + T_g) + y(M_t + F_t + T_g) - xyT_g] \tag{13}$$

$$H(y) = C_g - F_p - F_t - T_g + x(M_p + F_p + T_g) + y(M_t + F_t + T_g) - xyT_g \tag{14}$$

$$\frac{\partial H(y)}{\partial y} >$$

When government regulation is entirely strict:  $F(z) = 0$  and  $dF(z)/dz < 0$ . Because of  $\frac{\partial H(y)}{\partial y} > 0$  that  $H(y)$  is positively correlated with  $y$ . Therefore: when  $y = \frac{C_g - F_p - F_t - T_g - x(M_p + F_p + T_g)}{M_t + F_t + T_g - xT_g} = y^{**}$ ,  $H(y) = 0$ ,  $dF(z)/dz = 0$ , the stable strategy cannot be determined; when  $y < y^{**}$ ,  $H(y) < 0$ ,  $dF(z)/dz|_{z=0} < 0$ ,  $z = 1$ , is ESS, on the other hand  $z = 0$  is ESS Government regulatory department phase diagram, as shown in Figure 4.

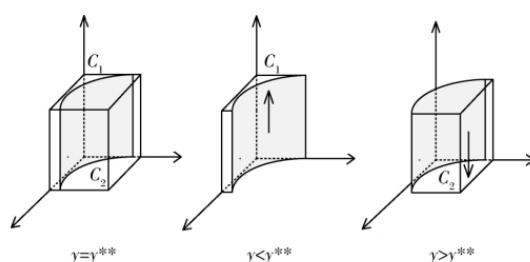

**Figure 4.** Phase diagram of the strategic evolution of government regulatory agencies.

From Figure 4, the probability of strict regulation by the government regulator is the same as the volume  $V_{C1}$  of  $C1$ . The volume  $V_{C2}$  of  $C2$  is the same as the probability of lax regulation by the government regulator.

$$V_{C1} = \int_0^1 \int_0^1 \frac{F_p + F_t + T_g - C_g - x(M_p + F_p + T_g)}{(F_t + M_t + T_g - xT_g)} dx dy$$

$$= \frac{M_p + F_p + T_g}{T_g} - \left[ \frac{M_p + F_p + C_g}{T_g} + \frac{(M_p + F_p)(M_t + F_t)}{T_g^2} \right] \ln \left( 1 + \frac{T_g}{M_t + F_t} \right) \tag{15}$$

$$V_{C2} = \left[ \frac{M_p + M_t + C_g}{T_g} + \frac{(M_p + F_p)(M_t + F_t)}{T_g^2} \right] \ln \left( 1 + \frac{T_g}{M_t + F_t} \right) - \frac{M_p + F_p}{T_g} \tag{16}$$

**Corollary 5:** The probability of tough measures by government regulators is related to many factors. Among them, government fines for RMSEs and administrative penalties for ineffective government regulation will increase the probability of tough regulation. Conversely, government regulators' incentives for drug manufacturers and third-party investors reduce the likelihood of tough measures. Moreover, the relationship between the amount of government fines imposed on third-party investors and the probability of strict regulation is complicated by a number of factors.

**Proof:** According to  $V_{C1}$ , find the first-order partial derivatives of each element respectively. Since  $1 - M_t + F_t + C_g < \ln(1 + T_g / M_t + F_t) < T_g / M_t + F_t$ , we get  $\partial V_{C1} / \partial F_t > 0$  (st  $(M_p + M_t + C_g) - (M_t + F_t + C_g) > 0$ ),  $\partial V_{C1} / \partial M_p < 0$ ,  $\partial V_{C1} / \partial M_t < 0$ ,  $\partial V_{C1} / \partial T_g > 0$ , so  $(M_g + M_t + C_g) - (M_t + F_t + C_g) > 0$  when,  $F_t$  increases, can  $V_{C1}$  increase. In addition,  $F_t$ ,  $T_g$  increasing or  $M_p$ ,  $M_t$  decreasing can increase the regulatory stringency rate of government regulatory authorities.

Corollary 5 suggests that there are a number of factors that contribute to strict regulation by government regulators. On the one hand, the higher the fine set by the government regulator, the stricter the government regulation; on the contrary, the higher the amount of reward, the lower the rate of strict government regulation. On the other hand, higher administrative penalties imposed on regulators by higher levels of government may motivate regulators to strictly fulfill their regulatory duties. In addition, increasingly strict government regulation may cause third-party investors to refuse to invest, thus reducing the high credit risk of RMSEs in the market and improving the operational stability of social RMSEs.

Corollary 6: In the evolutionary process, the rate of strict regulation by government regulators decreases as the rate of low credit risk or refusal to invest by third-party investors in RMSEs increases. Proof: Through the analysis of the evolutionary stability of the strategic choices of government regulatory agencies, it can be concluded that when  $y < y^{**}$ , immediately,  $x < [(1 - y)(F_t + T_g) + (F_p - C_g - yM_t)] / (M_p + F_p + T_g - yT_g)$   $z = 1$  it is an evolutionary stable strategy; as  $y$  and  $x$  increase, the probability of strict government supervision decreases from  $z = 1$  As small as  $z = 0$ , so  $z$  decreases as  $y$  and  $x$  increase.

Corollary 6 shows that the strict supervision rate of government regulatory authorities is affected by the strategic choices of RMSEs and third-party investors. When the credit risk of RMSEs is low or the probability of third-party investors refusing to invest is high, government regulatory authorities may reduce strict supervision, resulting in a lack of supervision. Therefore, government regulatory authorities should strengthen the supervision of RMSEs and third-party investors to ensure the rigor and stability of supervision, thereby maintaining market order and protecting consumer interests.

(4) Stability analysis of the equilibrium point of the three-party evolutionary game system From  $F(x) = 0, F(y) = 0, F(z) = 0$  the system equilibrium point can be obtained:

$E_1(0, 0, 0), E_2(1, 0, 0), E_3(0, 1, 0), E_4(0, 0, 1), E_5(1, 1, 0), E_6(1, 0, 1), E_7(0, 1, 1), E_8(1, 1, 1), E_9\left(0, \frac{F_p+F_t+T_g-C_g}{M_t+F_t+T_g}, \begin{pmatrix} B_t - \\ C_t \end{pmatrix} \begin{pmatrix} F_t + \\ M_t \end{pmatrix}\right), E_{10}((F_p + F_t + T_g - C_g) / F_p + M_p), E_{11}((F_p - M_t - C_g) / F_p + M_p), 1, (C_{ph} - C_{pl} - C_p - R_p) / (F_p + M_p), E_{12}((B_t - C_t) / B_t, (C_{ph} - C_{pl} - C_p - R_t) / (R_p - B_t)), E_{13}((B_t - M_t - F_t - C_t) / B_t, (C_{ph} - C_{pl} - C_p - B_t - F_p - M_p) / (R_p - B_t), 1). Because of  $x, y, z \in [0,1]$ , then  $E_9 \sim E_{13}$  under certain conditions, existence is meaningful, and because of  $(C_{ph} - C_{pl} - C_p - R_p) < 0$ , it is  $E_{11}$  meaningless. The Jacobian matrix of the third-party evolutionary the game system is:$

$$\begin{aligned}
 J &= \begin{bmatrix} J_1 & J_2 & J_3 \\ J_4 & J_5 & J_6 \\ J_7 & J_8 & J_9 \end{bmatrix} = \begin{bmatrix} \frac{\partial F(x)}{\partial x} & \frac{\partial F(x)}{\partial y} & \frac{\partial F(x)}{\partial z} \\ \frac{\partial F(y)}{\partial x} & \frac{\partial F(y)}{\partial y} & \frac{\partial F(y)}{\partial z} \\ \frac{\partial F(z)}{\partial x} & \frac{\partial F(z)}{\partial y} & \frac{\partial F(z)}{\partial z} \end{bmatrix} \\
 &= y(y - 1)[-F_t - M_t]z(z - 1)[F_p + M_p + T_g - yT_g] \\
 &= \begin{bmatrix} (2x - 1)[-C_{pl} - C_p - B_t - y(R_p - B_t)] - z(F_p + M_p) & x(x - 1)[B_t - R_p] & x(x - 1)(-F_p - M_p) \\ y(y - 1)[-B_t] & (2y - 1)[(1 - x) - B_t - z(F_t + M_t) - C_t] & y(y - 1) \end{bmatrix} \tag{17}
 \end{aligned}$$

According to Liapunov’s first rule, the equilibrium point of a dynamical system is asymptotically stable when the real part of all eigenvalues of the Jacobi matrix is negative (Matt et al., 2015). The equilibrium point is unstable if the real part of at least one eigenvalue of the Jacobi matrix is positive. If the real part of the Jacobi matrix is negative except for the real part of the eigenvalues, which is zero (Altaf & Shah, 2018; Ma & Ma, 2020; Vives, 2019), the equilibrium point is in a critical state and its stability cannot be determined by the sign of the eigenvalues (Deloof & Rocca, 2015; Huang et al., 2019). Therefore, the stability of the equilibrium point of the system can be determined by analyzing the eigenvalues of the Jacobi matrix. As shown in Table 2.

**Table 2.** Equilibrium point stability analysis.

equilibrium point	Jacobian matrix eigenvalues $\lambda_1, \lambda_2, \lambda_3$	Stability conclusion		
		real part sign	condition	
$E_1 = (0, 0, 0)$	$C_{pl} - C_{ph} + C_p + B_t + C_t, F_p + T_g + F_t - C_g$	(-, -, +)	~	\
$E_2 = (1, 0, 0)$	$C_{ph} - C_{pl} - C_p - B_t, F_t - C_g - M_p$	(+, +, ×)	~	\
$E_3 (0, 1, 0)$	$C_{pl} - C_{ph} + C_p - R_p, F_p - M_t - C_g$	(+, +, ×)	~	\
$E_4 (0, 0, 1)$	$C_{pl} - C_{ph} + C_p + B_t + C_t + M_p, M_t + F_t + C_t - B_t, C_g - F_p - F_t - T_g$	(-, -, -)	ESS	①
$E_5 (1, 1, 0)$	$C_{ph} - C_{pl} - C_p - R_p, -C_g - M_p - M_t,$	(-, -, -)	ESS	\
$E_6 (1, 0, 1)$	$C_{ph} - C_{pl} - C_p - B_t - F_p - M_p, F_t + M_t + C_t, C_g + M_p - F_t,$	(×, +, ×)	~	\
$E_7 (0, 1, 1)$	$C_{pl} - C_{ph} + C_p + R_p + F_p + M_p, B_t - M_t + F_t - C_t, C_g + M_t - F_p$	(+, ×, ×)	~	\
$E_8 (1, 1, 1)$	$C_{ph} - C_{pl} - C_p - R_p - F_p - M_p, -F_t - M_t - C_t, C_g + M_t + M_p$	(-, -, +)	~	\
$E_9 (0, y_1, z_1)$	$a_1, \lambda_1 = \lambda_3 = \sqrt{y_1(1 - y_1)(F_t + M_t)z_1(1 - z_1)(M_t + F_t + T_g)}$	(-, 0, 0)	~	②
$E_{10} (x_1, 0, z_2)$	$a_2, \lambda_2 = \lambda_3 = \sqrt{x_1(1 - x_1)(F_p + M_p)z_1(1 - z_1)(M_p + F_p + T_g)}$	(-, 0, 0)	~	③
$E_{11} (x_2, y_2, 0)$	$a_3, \lambda_2 = -\lambda_3 = \sqrt{x_2(1 - x_2)(R_p + B_t)y_2(1 - y_2)B_t}$	(×, +, -)	~	④
$E_{12} (x_3, y_3, 1)$	$a_4, \lambda_2 = -\lambda_3 = \sqrt{x_3(1 - x_3)(R_p + B_t)y_3(1 - y_3)B_t}$	(×, +, -)	~	⑤

Note: x means uncertainty and means instability,  $x_1, x_2, x_3, y_1, y_2, y_3, z_1, z_2$  are the coordinates of the corresponding equilibrium point respectively. If the conditions corresponding to the equilibrium point are not met, the equilibrium point is unstable or meaningless. ①  $C_{pl} - C_{ph} + C_p + B_t + C_t + M_p < 0$  ②  $a_1 < 0, F_p - C_g < M_t, B_t - M_t - F_t - C_t < 0$  ③  $a_2 < 0, F_t - C_g < M_p, C_{ph} - C_{pl} - C_p - B_t - F_p - M_p < 0$  ④  $B_t - C_t > 0, C_{ph} - C_{pl} - C_p - B_t > 0$  ⑤  $B_t - M_t - F_t - C_t > 0, C_{ph} - C_{pl} - C_p - B_t > 0$

Corollary 7: When  $C_{pl} - C_{ph} + C_p + B_t + C_t + M_p < 0, B_t + M_t + F_t + C_t < 0$ , there are two stable points in a replicated dynamic system  $E_4(0, 0, 1), E_5(1, 1, 0)$ .

Proof: According to Table 2, the conditions are met at this time ①, so  $E_4(0, 0, 1)$  and  $E_5(1, 1, 0)$  are the asymptotic stable points of the system. If the conditions ②③ do not meet the situation, the equilibrium point  $E_9(0, y_1, z_1)$  is  $E_{10}(x_1, 0, z_2)$  worthless. If all conditions ④⑤ apply, the equilibrium point  $E_{11}(x_2, y_2, 0), E_{12}(x_3, y_3, 1)$  is an unstable point.

Corollary 7 suggests that when government penalties and incentives are not sufficient to influence the strategic choices of RMSEs and third-party investors, or when rural MSEs have high credit risk and high returns to speculation, and when third-party investors have high returns to rent-seeking, the initial point of choice for tripartite investors should be determined (high credit risk, willingness to rent-seeking, low credit risk, no rent-seeking, light regulation). At this point, government regulation is ineffective in restraining the behavior of RMSEs and third-party investors, and RMSEs with high credit risk jeopardize the stability of the social enterprise market. In order to avoid a combination of stabilization strategies (i.e., the high credit risk of RMSEs, strong rent-seeking intentions of third-party investors, and a low rate of strict regulation by the government regulator), the regulator needs to set fines or incentives sufficiently large to make the incentive and penalty mechanisms effective. This can influence the strategic choices of rural MSMEs and third-

party investors, thereby increasing the rate of strict supervision by government regulators and avoiding the emergence of regulatory deficiencies.

Corollary 8: When  $F_p + M_p > C_{ph} - C_{pl} - C_p - B_t > 0$ ,  $M_t + F_t > B_t - C_t > 0$  When, the system has at least one stable point  $E_5(1, 1, 0)$ , and  $F_p - M_t > C_g$ ,  $F_t - M_p > C_g$  when it is satisfied, the replica dynamic system has and has only one stable point  $E_5(1, 1, 0)$ .

Proof: When  $F_p + M_p > C_{ph} - C_{pl} - C_p - B_t > 0$ ,  $M_t + F_t > B_t - C_t > 0$  When, according to Table 2, does not meet the conditions ①, ⑤, it is an unstable point and is  $E_4(0, 0, 1)$   $E_{12}(x_3, y_3, 1)$  meaningless; in this case, if it meets the conditions ④, it  $E_{12}(x_3, y_3, 1)$  is an unstable point; conditions ②, ③they require more factors to judge. When we add another condition  $F_p - M_t > C_g$ ,  $F_t - M_p > C_g$ , the condition ②, ③is not satisfied, and at this time  $E_9(0, y_1, z_1)$ ,  $E_{10}(x_1, 0, z_2)$  It makes no sense that there is only one stable point in a replicated dynamic system  $E_5(1, 1, 0)$ .

Corollary 8 suggests that the amount of rewards and penalties limited to government regulators should be higher than the amount of respective behavioral returns of RMSEs and investors, so as to ensure the emergence of behavioral combinations in the game among the three (low credit risk of RMSEs, investors' willingness to seek rent and strict supervision by the government). And, RMSEs cost income, cost of regulation, and government regulators in the exercise of the process of ineffective, government regulators will also suffer the amount of administrative penalties, the amount of change in the evolution of the game for the results of the impact. Furthermore, the government will be in accordance with the RMSEs under the set reasonable requirements, set the corresponding rewards and penalties rules, and effectively reduce the number of times the equilibrium point of the mixed strategy occurs. For example, the cost of the government regulatory department is less than the difference between the amount of fines for RMSEs and the amount of incentives for investors. It can be seen that the reasonable design of the government regulatory mechanism rules can effectively protect the social market credit stability of small and micro enterprises in rural areas and promote the steady development of all types of enterprises.

### 3. Results

Using Python tools, assignments are made in conjunction with the questionnaire values to verify the stability of the conclusions obtained from the evolutionary game, and the strategy model is analyzed. Obtain array 1, which satisfies the conditions in Corollary 8 above:  $R_p = 150$ ,  $C_{ph} - C_{pl} = 85$ ,  $C_p = 10$ ,  $B_t = 40$ ,  $F_p = 40$ ,  $M_p = 20$ ,  $F_t = 20$ ,  $M_t = 15$ ,  $C_t = 10$ ,  $C_g = 15$ ,  $T_g = 40$ . Based on the above array 1  $R_p$ ,  $B_t$ ,  $F_t$ ,  $M_t$ ,  $M_p$ ,  $T_g$ , Analyze the impact on evolutionary game processes and outcomes.

First,  $R_p$  as an analysis of the changes that will have an impact on the game process and results,  $R_p$ three numerical values are assigned. as follows  $R_p = 100, 150, 200$ , running through Python, you can get the data model after the game evolves 50 times, as shown in Figure 5 below.

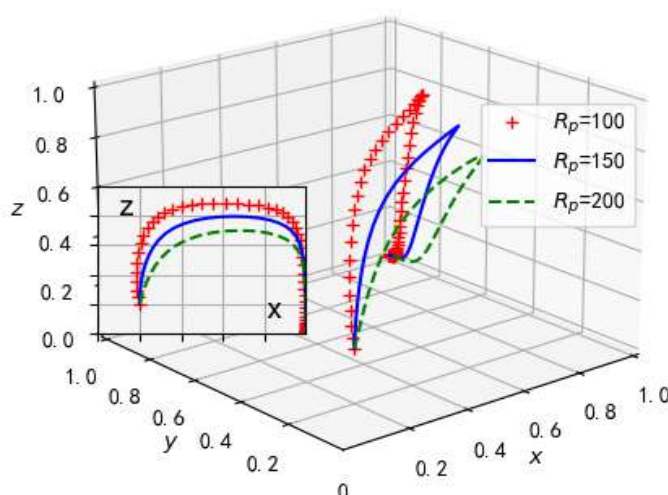

Figure 5. Income Impact Chart of RMSEs.

As can be seen from the above figure, the overall result tends to a stable point in the process, when the increase in the overall benefits received by RMSEs ensures a stable rate of evolution of credit risk in RMSEs. As  $R_p$  increases, the probability of low credit risk of RMSEs increases, then the probability of strict regulation will reduce. Therefore, when the government regulators supervise RMSEs, they should do strict supervision of the credit risk of RMSEs, which focuses on the

control of some remote areas and rural areas with relatively difficult operation and relatively low returns and can moderately relax the control of the operating status of rural microenterprises to ensure the credit risk of rural microenterprises.

When  $B_t$  analyzing the changes in the evolutionary game, yes  $B_t$  assignment,  $B_t = 20, 40, 60$ , the running results are shown in Figure 6.

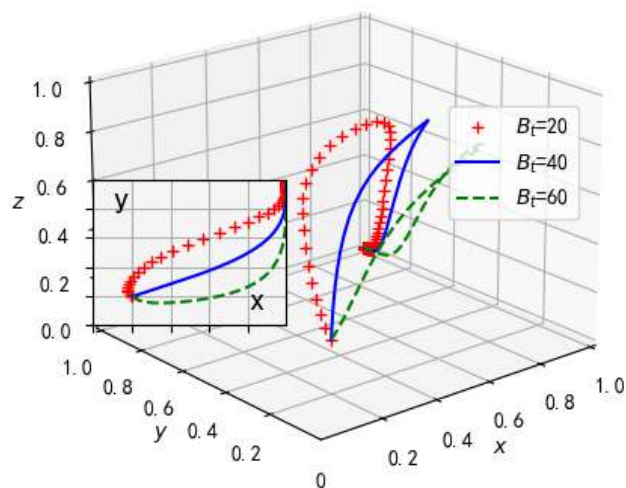

Figure 6. Investment cost impact diagram.

The investment cost impact diagram shows that as  $B_t$  the credit risk of RMSEs rises, the probability of low credit risk is gradually increasing, and the probability of third-party investors' investment behavior of "rejecting investment" is also decreasing. In order to ensure that the credit risk stability of RMSEs plays a role in the market, government regulatory authorities can use the ability of social media disclosure to enhance the impact of the credit risk reputation of RMSEs and increase investment in RMSEs where credit risks arise. costs, increasing the probability of producing low credit risk.

Next, assigned respectively  $F_t = 0, 20, 40$ , and the analysis model results are shown in Figure 7.

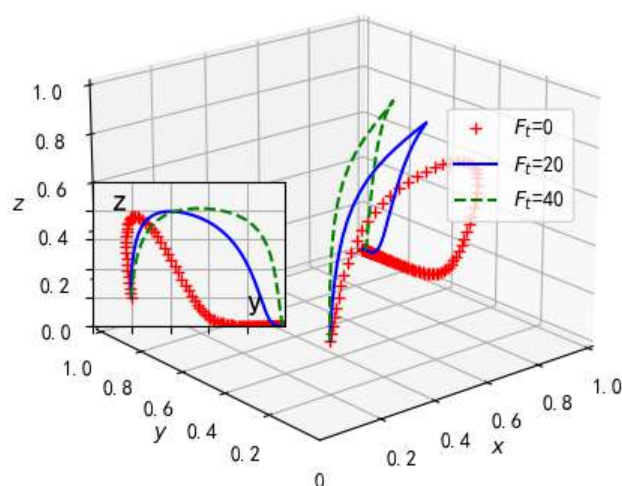
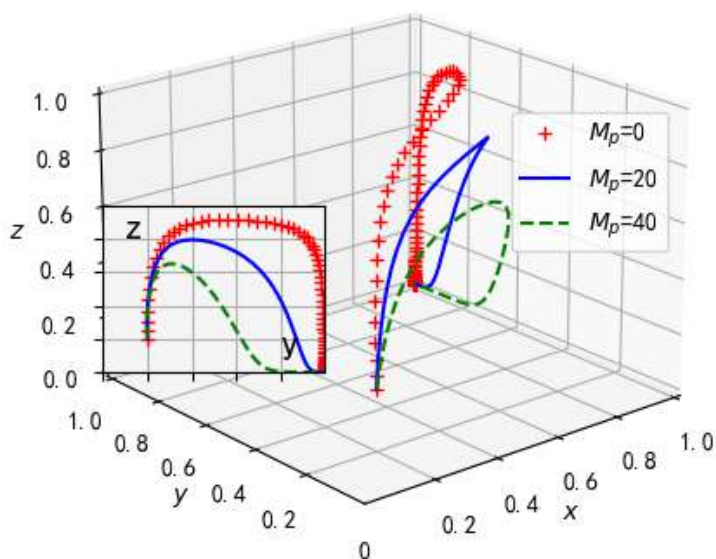

Figure 7. Government's influence on third-party investors.

Figure 7 shows that before the credit risk of RMSEs is low and the credit risk is stable, increasing the probability of government regulatory authorities implementing strict supervision increases. When the credit risk of RMSEs is low, the credit risk probability tends to be stable.  $F_t$  After 1, the probability of strict government regulation gradually decreases and stabilizes at 0, and  $F_t$  an increase will increase the probability of third-party investors' "rejection of investment" behavior.

Assigned respectively  $M_t = 0, 15, 30$ , the analysis model results are shown in Figure 8.



**Figure 8.** Government’s influence on RMSEs.

As the impact of government regulatory departments on RMSEs  $M_t$  increases, the rate of strict supervision by government regulatory departments will decrease during the implementation process. In order to prevent fixed payments, government regulatory authorities should adopt reasonable reward and punishment measures and convert payments to third-party investors into rewards. This can encourage third-party investors to assume the responsibility of protecting the social enterprise economy and promote economic stability.

Then assigning  $M_p$  values to respectively.  $M_p=0, 20, 40$ . The model generated after running the results 50 times is shown in Figure 9.

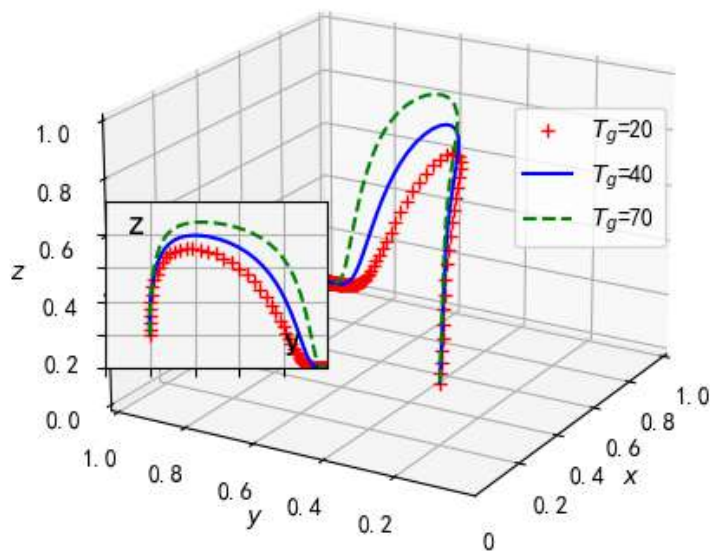
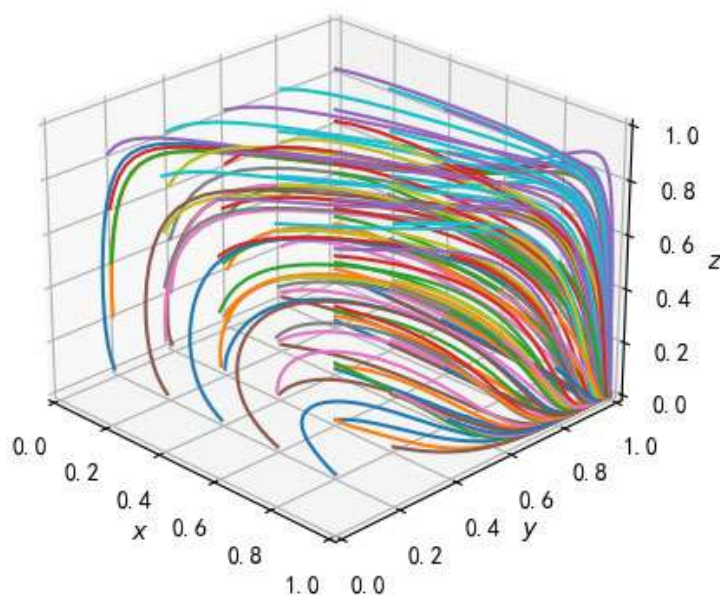

**Figure 9.** The impact of weak government supervision.

The graph of government supervision Figure 9 shows that when the game tends to a stable value, as  $M_p$  the increase in, the rate of strict government supervision will decrease, and the rate of third-party investors taking “rejection of investment” behavior will increase.

For  $T_g$  assignment,  $T_g=20, 40, 70$ , the running model diagram is shown in Figure 10.

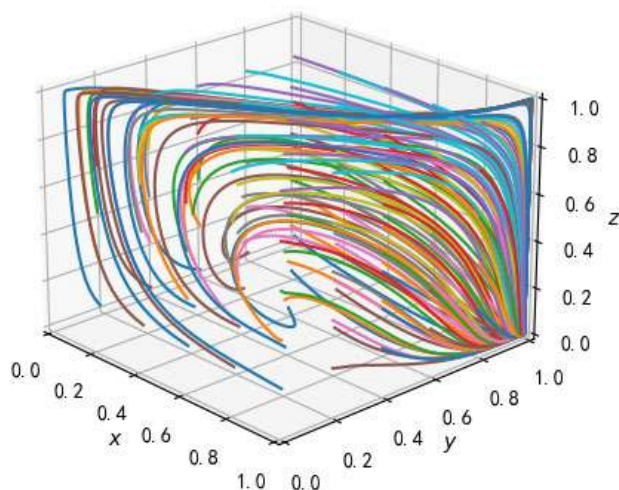



**Figure 10.** The result of array evolution 50 times.

Figure 10 shows that the credit risk of RMSEs is low. After the credit risk stabilizes at 1,  $T_g$  it rises, and the probability of strict government supervision increases. It can be seen that although the government’s regulatory reward and punishment mechanism can ensure the stability of the credit risk of RMSEs, it does not facilitate the government regulatory authorities to supervise themselves during the supervision process. Administrative rewards and punishments implemented by higher-level governments can enable regulatory authorities to increase the rate of strict supervision and further improve the robustness of credit risks of RMSEs.

Array 1 can provide the basis required in Corollary 6. Assign array 2:  $R_p = 150, C_{ph} - C_{pl} = 105, C_p = 10, B_t = 50, F_p = 25, M_p = 15, F_t = 18, M_t = 12, C_t = 10, C_g = 15$  which meets the requirements in Corollary 5. The values change according to time and evolve 50 times. The running results are shown  $T_g = 40$  in Figure 11.



**Figure 11.** Array 2 evolution 50 times results.

50 evolutions of array 2 shows in the figure that  $F_{10}(x_1, 0, z_2)$  it is an unstable point in the equilibrium point. It can be concluded that the behavior value of the state  $Gy$  combination point at this point is (low credit risk, refusal to invest, and loose supervision), which is consistent with the results of Corollary 6, under the condition ①, there are two stable points in the operating data:  $(0, 0, 1)$  and  $(1, 1, 0)$ , the corresponding stable strategic behavior combinations are (high credit risk, intention to invest, strict supervision) and (low credit risk, refusal to invest, loose supervision). Therefore, government regulatory authorities must establish a complete information network to

help understand the interests of RMSEs and third-party investors, promptly adopt rewards and punishments for both, and promptly avoid the harm of excessive credit risks of RMSEs. The phenomenon of economic stability of small and micro enterprises in rural areas. It can be seen that the control model analysis and stability analysis of various strategies are the same and highly efficient, which has practical guiding significance for credit risk management of RMSEs.

#### 4. Discussion and Implications

Given the status of small and micro enterprises in rural growth, the following research is conducted in this paper. ① Investigate the process of correlation between the influencing factors, pinpoint the primary factors impacting the credit risk of rural small and micro businesses, and establish a foundation for the ensuing game assumptions. Examine the primary elements influencing the credit risk of small and micro businesses in rural locations, taking into account the information team's reputation, moral hazard, the enterprise's own environmental impact, the external environment, and credit reward and punishment mechanisms; ② Through the method of evolutionary game theory, combined with the collected relevant data, Combining theory with practice, establish relevant game analysis models, make basic assumptions, and conduct detailed analysis of the participants, information, probabilities, and strategies in the assumptions, taking the retail industry enterprises in RMSEs and various subjects of credit risk issues as examples. The main research object is to use game analysis to build a decision tree, analyze the relationship between various subjects, achieve game equilibrium, and obtain relevant information from the results of game analysis to provide relevant basis for proposing relevant and effective countermeasures on how to control the credit risk of RMSEs; ③ Analyze the final conclusion, build a control model, and propose relevant and effective control strategies for the credit risk of RMSEs.

Considering the possibility of credit risk investment behavior of RMSEs and third-party investors, this paper builds an evolutionary game theory by using the evolutionary game theory on the credit risk of RMSEs and their decision-making role of the three "RMSEs, third-party investors and government regulators", discusses the stability of decision-making among the three, and then verifies the validity of the conclusions obtained by participating in the control model. In evolutionary game theory, the stability of the six combinations, as well as the relationship between the interaction of the various elements, and then the conclusions obtained, participation in the control model to verify the validity of the conclusions, to give the credit risk of RMSEs and the third-party investment behavior resulting in the stability of the portfolio of strategies to meet the corresponding conditions, and the influence of the relationship between the various factors and the stability of the requirements of the rural microenterprises on the issue of credit risk to put forward the relevant strategies. The strategy is proposed to the credit risk of small and micro enterprises in rural areas.

The main conclusions are as follows: government regulators, by increasing the strength of incentives and penalties will be conducive to the stabilization of the credit risk of rural microenterprises, but on the contrary, to increase the strength of incentives and penalties will have a negative impact on the exercise of government responsibilities. In order to maintain the overall market environment, where the credit risk of rural microenterprises tends to stabilize the state, the relevant government departments should be consistent in their adjustments to the incentives and penalties mechanism, allowing them to gain less than the incentives and penalties. An important means to increase the stability of the credit risk of RMSEs is the accountability of the higher level of leadership of the government to the supervisory authorities for their own lack of responsibility. In addition, the growth of RMSEs' own industry revenue is also an effective means to avoid the occurrence of high credit risk in RMSEs.

#### 5. Conclusions

The issue of how to address small and microbusiness financing challenges in rural areas is one that requires consideration during the development process. To solve this dilemma, we must first focus on solving its root cause. The credit risks faced by rural microenterprises must be taken seriously. No matter which method RMSEs adopt to finance, credit risk plays a crucial role. Therefore, the analysis of credit risks of RMSEs is crucial. Explore the factors that influence the development of credit risks in RMSEs, analyze pertinent factors, use games, and compare the ideas and characteristics of these businesses with traditional credit risks from various perspectives and scenarios. The analytical method is to conduct a targeted analysis of the key causes of credit risks in RMSEs, and thereby propose targeted control strategies and build a control model for research.

During the research process, this article only considered the credit risks of RMSEs in their own operations and the credit risk supervision issues caused by investors under the conditions of information asymmetry and limited rationality. It ignored the part that small, and micro businesses play in the market in rural areas. In the face of different market turbulences, the robustness of credit risks caused by unexpected phenomena has declined, and the impact of the game order of each

subject during the game has not been taken into account. Therefore, it is possible to appropriately involve influencing factors such as feedback from objects participating in the consumption behavior of rural microenterprises, improve the evolutionary game model under the participation of consumers involved in rural small microenterprises, and study the operation of rural microenterprises in the face of the market environment. The changes in the existing credit risk can provide innovative thinking and suggestions for the follow-up research to explore and analyze the credit risk game of rural microenterprises.

**Author Contributions:** **Xi Zhou:** Conceptualization; **Chuang Yang:** Writing – original draft; **Caiyu Wan:** Data curation; **Wei Gao:** Investigation; **Suping Ye:** Formal analysis; **Lingyan Wu:** Visualization; **Luyao Liu:** Writing – review & editing.

**Funding:** This research was funded by the National Statistical Science Research Project (2023LY098) and the Talent Launch Project of Scientific Research Development Fund of Jiyang College of Zhejiang A&F University (RC2021D10).

**Data Availability Statement:** Not applicable.

**Acknowledgments:** Informed consent was obtained from the respondents of the survey.

**Conflicts of Interest:** The authors declare no conflict of interest.

## Reference

- Abdel-Basset, M., Mohamed, R., Sallam, K., & Elhoseny, M. (2020). A novel decision-making model for sustainable supply chain finance under uncertainty environment. *Journal of Cleaner Production*, 269. <https://doi.org/10.1016/j.jclepro.2020.122324>
- Altaf, N., & Shah, F. A. (2018). Investment and financial constraints in Indian firms: Does working capital smoothen fixed investment? *Decision*, 45, 43–58. <https://doi.org/10.1007/s40622-018-0178-8>
- Blanco-Oliver, A., Reguera-Alvarado, N., & Veronesi, G. (2021). Credit risk in the microfinance industry: The role of gender affinity. *Journal of Small Business Management*, 59(2), 280–311. <https://doi.org/10.1080/00472778.2020.1844487>
- Boushnak, E., Rageb, M. A., Ragab, A. A., & Sakr, A. M. (2018). Factors influencing credit decision for lending SMEs: A case study on National Bank of Egypt. *Open Access Library Journal*, 5(11), 1–17, Article e4996. <https://doi.org/10.4236/oalib.1104996>
- Breeden, J. L. (2021). A survey of machine learning in credit risk. *Journal of Credit Risk*, 17(3), 1–62. <https://doi.org/10.21314/JCR.2021.008>
- Deloof, M., & La Rocca, M. (2015). Local financial development and the trade credit policy of Italian SMEs. *Small Business Economics*, 44(4), 905–924. <https://doi.org/10.1007/s11187-014-9617-x>
- Fang, F. (2022). Credit Risk Evaluation Model of Small-Micro Enterprises for Rural Commercial Bank Based on XGBoost and Random Forest. In *Proceedings of the 2022 International Conference on E-business and Mobile Commerce* (pp. 125–131). <https://doi.org/10.1145/3543106.3543127>
- Gray, J., & Rumpe, B. (2017). Models for the digital transformation. *Software & Systems Modeling*, 16, 307–308. <https://doi.org/10.1007/s10270-017-0596-7>
- He, M., & Hu, W. (2018). The research about the credit risk assessment of small and medium-sized enterprises from the perspective of Supply Chain Finance—The comparative study based on the Logistic regression model & the BP Neural Network Model. *Finance*, 8, 128–136.
- Huang, L., Ying, Q., Yang, S., & Hassan, H. (2019). Trade credit financing and sustainable growth of firms: Empirical evidence from China. *Sustainability*, 11(4), 1032. <https://doi.org/10.3390/su11041032>
- Jones, S., Johnstone, D., & Wilson, R. (2015). An empirical evaluation of the performance of binary classifiers in the prediction of credit ratings changes. *Journal of Banking & Finance*, 56, 72–85. <https://doi.org/10.1016/j.jbankfin.2015.02.006>
- Kotarba, M. (2016). New factors inducing changes in the retail banking customer relationship management (CRM) and their exploration by the FinTech industry. *Foundations of management*, 8(1), 69–78. <https://doi.org/10.1515/fman-2016-0006>
- Kuang, H., Du, H., & Feng, H. (2020). Construction of the credit risk indicator evaluation system of small and medium-sized enterprises under supply chain finance. *Science Research Management*, 41(4), 209. <https://www.kygl.net.cn/EN/abstract/abstract22090.shtml>
- Li, L., Su, F., Zhang, W., & Mao, J. Y. (2018). Digital transformation by SME entrepreneurs: A capability perspective. *Information Systems Journal*, 28(6), 1129–1157. <https://doi.org/10.1111/isj.12153>
- Lu, P. (2018). Research on the amplification effect of financial moral hazard in agricultural supply chain. *Financial Research*, 4, 88–103. [https://kns.cnki.net/kcms2/article/abstract?v=MTbc36RhFpQnwB5G58Mj7sAMHbxOoXD\\_cS8Z0v6PERevaL\\_Jh2gchOsCherym5727liOm2VWZaxhZfSixTiTN0L30rNchb\\_yrdG59MV1D6X4oDvXhIWIZW5YiA-FFdrRwV\\_op6p0L3A=&uniplat-form=NZKPT&language=gb](https://kns.cnki.net/kcms2/article/abstract?v=MTbc36RhFpQnwB5G58Mj7sAMHbxOoXD_cS8Z0v6PERevaL_Jh2gchOsCherym5727liOm2VWZaxhZfSixTiTN0L30rNchb_yrdG59MV1D6X4oDvXhIWIZW5YiA-FFdrRwV_op6p0L3A=&uniplat-form=NZKPT&language=gb)
- Ma, L., & Ma, S. (2020). Trade credit use and bank loan access: An agency theory perspective. *Accounting & Finance*, 60(2), 1835–1865. <https://doi.org/10.1111/acfi.12517>
- Matt, C., Hess, T., & Benlian, A. (2015). Digital transformation strategies. *Business & information systems engineering*, 57, 339–343. <https://doi.org/10.1007/s12599-015-0401-5>
- Meng, B., & Chi, G. (2015). New combined weighting model based on maximizing the difference in evaluation results and its application. *Mathematical Problems in Engineering*, 2015. <https://doi.org/10.1155/2015/239634>
- Mhlanga, D. (2021). Financial inclusion in emerging economies: The application of machine learning and artificial intelligence in credit risk assessment. *International Journal of Financial Studies*, 9(3), 39. <https://doi.org/10.3390/ijfs9030039>
- Nufus, E. H., Zuhroh, I., & Suliswanto, M. S. W. (2021). Analysis of COVID-19 impact on micro, small, and medium enterprises (MSMEs) credit distribution in East Java Banks. *Journal of Accounting and Investment*, 22(2), 342–360. <https://doi.org/10.18196/jai.v22i2.10701>
- Pratama, M., Lu, J., Lughofer, E., Zhang, G., & Er, M. J. (2016). An incremental learning of concept drifts using evolving type-2 recurrent fuzzy neural networks. *IEEE Transactions on Fuzzy Systems*, 25(5), 1175–1192. <https://doi.org/10.1109/TFUZZ.2016.2599855>
- Serrano-Cinca, C., Gutiérrez-Nieto, B., & Reyes, N. M. (2016). A social and environmental approach to microfinance credit scoring. *Journal of Cleaner Production*, 112, 3504–3513. <https://doi.org/10.1016/j.jclepro.2015.09.103>

- Shi, B., Zhao, J., & Wang, J. (2016). A credit rating attribute reduction approach based on pearson correlation analysis and fuzzy-rough sets. *ICIC Express Letters*, 10(2), 519–525.
- Shi, B., Zhao, X., Wu, B., & Dong, Y. (2019). Credit rating and microfinance lending decisions based on loss given default (LGD). *Finance Research Letters*, 30, 124–129. <https://doi.org/10.1016/j.frl.2019.03.033>
- Singh, A., & Hess, T. (2020). Strategic Information Management. In R. D. Galliers, D. E. Leidner (Eds.), *How chief digital officers promote the digital transformation of their companies* (pp. 202–220). Routledge. <https://doi.org/10.4324/9781315880884>
- Tan, X., Zhang, H. (2018). Research on supply chain financial decision-making based on buyback under information asymmetry. *Nankai Economic Research*, 1, 104–123. <https://link.cnki.net/doi/10.14116/j.nkes.2018.01.007>
- Vives, X. (2019). Digital disruption in banking. *Annual Review of Financial Economics*, 11, 243–272. <https://doi.org/10.1146/annurev-financial-100719-120854>
- Wang, S., Qi, Y., Fu, B., & Liu, H. (2016). Credit risk evaluation based on text analysis. *International Journal of Cognitive Informatics and Natural Intelligence (IJCINI)*, 10(1), 1–11. <https://doi.org/10.4018/IJCINI.2016010101>
- Yang, Y., Chu, X., Pang, R., Liu, F., & Yang, P. (2021). Identifying and predicting the credit risk of small and medium-sized enterprises in sustainable supply chain finance: Evidence from China. *Sustainability*, 13(10), 5714. <https://doi.org/10.3390/su13105714>
- Zhu, Y., Zhou, L., Xie, C., Wang, G. J., & Nguyen, T. V. (2019). Forecasting SMEs' credit risk in supply chain finance with an enhanced hybrid ensemble machine learning approach. *International Journal of Production Economics*, 211, 22–33. <https://doi.org/10.1016/j.ijpe.2019.01.032>

## Masthead

### Editor-in-Chief



Prof. Dr. Junbiao Zhang (editor\_in\_chief@sccpress.com)

Rural Revitalization Academy of Zhejiang Province, Zhejiang A&F University, Hangzhou, Zhejiang, 311300, China.

### Founder & Executive Editor



Prof. Dr. Yanxiong Wu (yxwu@sccpress.com)

Rural Revitalization Academy of Zhejiang Province, Zhejiang A&F University, Hangzhou, Zhejiang, 311300, China.

### Editorial Board Members



Chair Prof. Dr. Shenggen Fan (s.fan@cau.edu.cn)

College of Economics and Management, China Agricultural University, Beijing, 100083, China.



Prof. Dr. Rodney Smith (smith142@umn.edu)

College of Food, Agricultural and Natural Resources Sciences, University of Minnesota, St. Paul, MN 55108, USA.



Prof. Dr. Donald Huisingh (dhuisin@utk.edu)

Institute for a Secure and Sustainable Environment University of Tennessee, Knoxville, TN 37996, USA.



Prof. Dr. Yueqin Shen (shenyueqin@zafu.edu.cn)

Rural Revitalization Academy of Zhejiang Province, Zhejiang A&F University, Hangzhou, Zhejiang, 311300, China.



Malaysia Academician, Prof. Dr. Tan Chin Ping (tancp@upm.edu.my)

Department of Food Technology, Faculty of Food Science and Technology, Universiti Putra Malaysia, 43400 UPM Serdang Selangor, Malaysia.



Prof. Dr. Robert Kozak (rob.kozak@ubc.ca)

Faculty of Forestry, The University of British Columbia, Vancouver, BC, V6T 1Z4, Canada.



Prof. Dr. Zuhui Huang (zhhuang@zju.edu.cn)

China Academy for Rural Development(CARD), Zhejiang University, Hangzhou, Zhejiang, 310058, China



Prof. Dr. Yongqin Chen (ydaavidchen@cuhk.edu.cn)

School of Humanities and Social Science, The Chinese University of Hong Kong, Shenzhen, Guangdong, 518172, China.



Prof. Dr. Xiangming Fang (xmfang@cau.edu.cn)

College of Economics and Management, China Agricultural University, Beijing, 100083, China.



Prof. Dr. Antonio Domingos Padula (antonio.padula@ufrgs.br)

School of Management, Federal University of Rio Grande do Sul (UFRGS), Porto Alegre, Rio Grande do Sul, CEP 90010-460, Brazil.



Prof. Dr. Sergio Schneider (schneide@ufrgs.br)

Sociology of Rural Development and Food Studies, Federal University of Rio Grande do Sul (UFRGS), Porto Alegre, Rio Grande do Sul, CEP 90010-460, Brazil.



Prof. Dr. Gaofeng (GEOFF) Wang (gwang@clemson.edu)

School of Agricultural, Forest and Environmental Sciences, Clemson University, Clemson, SC 29634-0317, USA.



Prof. Dr. Shaozhi Chen (chensz99@163.com)

Chinese Academy of Forestry, Beijing 100091, China.



Prof. Dr. Xiande Li (gjmy6160@caas.cn)

Institute of Agricultural Economics and Development, Chinese Academy of Agricultural Sciences, Beijing 100081, China.



Prof. Dr. Fanbin Kong (kongfanbin@aliyun.com)

Institute of Digital Forestry & Green Development, Nanjing Forestry University, Nanjing, Jiangsu, 210042, China.



Prof. Dr. Chengjun Wang (cjwang\_77@126.com)

School of Economics and Management, Hainan Normal University, Haikou, Hainan, 571127, China.



Prof. Dr. Gang Li (lggui@sina.com)

School of Economics, University of Chinese Academy of Social Sciences, Beijing, 102488, China.



Academician of NAAS of Ukraine, Prof. Dr. Maksym Melnychuk (melnychuk.maks@gmail.com)

Faculty of Agronomy and Forestry, Vinnytsia National Agrarian University, Sonyachna str., 21008 Vinnytsia, Ukraine.



Prof. Dr. Zhongke Feng (fengzhongke@126.com)

College of Forestry, Beijing Forestry University, Beijing, 100083, China.



Prof. Dr. Nikolaos E. Labrou (Lambrou@aau.gr)

Department of Biotechnology, Agricultural University of Athens, Athens, Gr-118 55, Greece.



Prof. Dr. Weiguang Pan (321391007@qq.com)

Rural Revitalization Academy of Zhejiang Province, Zhejiang A&F University, Hangzhou, Zhejiang, 311300, China.



Prof. Dr. Weiguang Wu (wuwgccap@126.com)

College of Economics and Management, Zhejiang A&F University, Hangzhou, Zhejiang, 311300, China.



Prof. Dr. Karl Behrendt (kbehrendt@harper-adams.ac.uk)

Food, Land & Agribusiness Management Department, Harper Adams University, Shropshire, TF10 8NB, UK.



Prof. Dr. Xavier Simón Fernández (xsimon@uvigo.gal)

Economía Aplicada, Facultad de Ciencias Económicas y Empresariales, Universidade de Vigo, Galicia, 36310, Spain.



Prof. Dr. Harsha Ratnaweera (harsha.ratnaweera@nmbu.no)

Faculty of Sciences and Technology, Norwegian University of Life Sciences, P.O. Box 5003, NO-1432 Ås, Norway.



Prof. Dr. Frank Berninger (frank.berninger@uef.fi)

Department of Environmental and Biological Sciences, Faculty of Science, Forestry and Technology, University of Eastern Finland, FI-80100 Joensuu, Finland.



Prof. Dr. Dejan Janković (dejan.jankovic@polj.uns.ac.rs)

Department of Agricultural Economics and Rural Sociology, Faculty of Agriculture, University of Novi Sad, 21102 Novi Sad, Serbia.



Prof. Dr. Vesna Rodić (vesna.rodic@polj.uns.ac.rs)

Department of Agricultural Economics and Rural Sociology, Faculty of Agriculture, University of Novi Sad, 21102 Novi Sad, Serbia.



Prof. Dr. Guanghui Xu (ghxu@zafu.edu.cn)

Mathematics & Computational Science College, Zhejiang A&F University, Hangzhou, Zhejiang, 311300, China.



Prof. Dr. Songheng Jin (shjin@zafu.edu.cn)

Forestry & Biotechnology College, Zhejiang A&F University, Hangzhou, Zhejiang, 311300, China.



Prof. Dr. Shi Yin (acadch@hrbeu.edu.cn)

College of Economics and Management, Hebei Agricultural University, Baoding, 071001, China.



Prof. Dr. Pablo Molina Derteano (pablomd2009@gmail.com)

Faculty of Social Sciences, University of Buenos Aires, Santiago del Estero, 1029 CABA, Argentina.



Associate Prof. Dr. Hao Chen (chenhao01@ruc.edu.cn)

School of Applied Economics, Renmin University of China, Beijing, 100872, China.



Researcher Giuseppe Pulighe (giuseppe.pulighe@crea.gov.it)

Research Center for Agricultural Policies and Bioeconomy, Council for Agricultural Research and Agricultural Economy Analysis, Rome, 00184, Italy.



Economist, Dr. Tingsong Jiang (tjiang@thecie.com.au)

The Centre for International Economics, Canberra, ACT, 2609, Australia.



Economist, Researcher Alhelí González Cáceres (alhelicaceres@seppy.org.py)

Center for Interdisciplinary Rural Studies, Asunción, 001230, Paraguay.

## Communication & Outreach



Associate Prof. Dr. Tatjana Brankov (tatjana.brankov@ef.uns.ac.rs)

Department of Agricultural Economics and Agribusiness, Faculty of Economics, University of Novi Sad, 24000 Subotica, Serbia.



Research Associate Dr. Laura Moritz (Moritz@iamo.de)

Leibniz Institute of Agricultural Development in Transition Economies (IAMO), Theodor-Lieser-Straße 2, 06120 Halle, Germany.

## Governance & Oversight



Assistant Prof. Dr. Xinjie Shi (xjshi1990@zju.edu.cn)

China Academy for Rural Development (CARD), Zhejiang University, Hangzhou, Zhejiang, 310058, China.



Associate Prof. Dr. Manolis Pagkalos (manolispagkalos@zafu.edu.cn)

Jiyang College, Zhejiang A & F University, Zhuji, Zhejiang, 311800, China.



# Call papers for Vol. 2, Issue 3

## 1. Organizational Culture

(1) **Mission:** “Establish a mind for the heaven and earth, establish a destiny for the people, carry forward the unique knowledge for the sages, and create peace for all generations.” (Zhang Zai/Hengqu, Philosopher; 1020-1077 CE) | “横渠四句”: 为天地立心, 为生民立命, 为往圣继绝学, 为万世开太平)

(2) **Vision:** Establish a Scholar Community Center (SCC) as a change-maker to seek a way out for agriculture, seek development for rural areas, and seek well-being for farmers.

(3) **Beliefs:** Open, Global, Trust-worthy and Quality-assured.

(4) **Values:** Add Value Around You (i.e., the journal adds value to the author, who in turn adds value to the journal).

(5) **Motto:** A&R | Born to Shine.

(6) **SCC Philosophy:** Uphold Equality, Diversity & Inclusion (EDI).

(7) **Journal Philosophy:** Promise Less, Deliver More.

(8) **Editorial Slogans:** Pour Your Heart into A&R; Find a Way Forward.

## 2. Aims and Scope

**A&R** is a peer-reviewed scholarly journal dedicated to being an international multidisciplinary and interdisciplinary platform for communicating advances in fundamental and applied studies on contemporary agricultural, rural and farmers' issues and policies, as broadly defined by the disciplines of economics, sociology, human geography and cognate subjects.

A&R publishes articles related with an emphasis on, but not limited to, the following:

(1) Sustainable agriculture and rural sustainable development.

(2) Farmer's well-being, rural poverty alleviation and women's studies.

(3) Smart agriculture, rural e-commerce and digital governance.

(4) Understanding and analysis of contemporary agricultural, rural and farmers' issues and policies (Chinese/domestic and global), as broadly defined by the disciplines of economics, sociology, human geography and cognate subjects.

(5) Other related novel sciences and technologies with agricultural and rural perspectives.

## 3. Article Types

**A&R** seeks to publish perspective, review, original research and commentary articles.

### 3.1 Perspective Article

Perspective articles provide a forum for authors to discuss models and ideas from a personal viewpoint. Perspectives typically range from 2,000 to 4,000 words (including the abstract, references, and figures). They should consist of (1) a short, pithy title; (2) an abstract (max. 250 words); (3) references (max. 35 items); and (4) up to two figures or tables.

### 3.2 Review Article

Review Articles are overviews of a specific field of scientific literature. They aim to synthesise and evaluate recent primary literature on a topic, address controversies or provide a comprehensive list of references. Review Articles should not exceed 10,000 words (excluding references) with up to 100 references.

### 3.3 Original Research Article

Original/Research Articles are full-length scientific publications of original (i.e., unpublished) research. They should not exceed 8,000 words (excluding references) and a maximum of 12 images. Research articles over 8,000 words will only be accepted subject to Editorial decisions on needing a lengthier publication.

### 3.4 Commentary Article

Commentaries are short, narrowly focused articles of contemporary interest, usually commissioned by journal editors, serving as science critiques. They can discuss a variety of topics: (1) previous research published in scientific journals and/or scholarly books; (2) current research trends; (3) emerging empirical phenomena and issues; and (4) policies on relevant agriculture, rural areas and farming/farmers-related topics. They should not exceed 1,000 words, with a maximum of 10 references (no figures or tables).

**If you have unpublished papers in hand, please feel free to submit your manuscripts online: [www.sccpress.com](http://www.sccpress.com)**



# To be

a leading academic journal

in the  
field of agricultural,  
rural and farmers' issues  
and policies.



## Agricultural & Rural Studies

Abstracted & Indexed In Google Scholar

#### Publisher

SCC PRESS

Address: Unit 811, Beverley Commercial Centre,  
87-105 Chatham Road South, Tsim Sha Tsui,  
Kowloon, Hong Kong S.A.R., China.

#### Zhejiang Editorial Office

Rural Revitalization Academy of Zhejiang Province,  
Zhejiang A&F University, Hangzhou, Zhejiang,  
311300, China.

#### Editorial Assistants

Travis Malone (travismalone@sccpress.com),  
Grace Li (grace@sccpress.com),  
Rui Zhang (ruizhang@sccpress.com)

#### Photographer

Dengrong Gan

#### Layout

Tao He



Academic Open Access Publishing  
Since 2023